

The Snyder Family History, all direct line relatives back to the Colonies

**The Petersen / Snyder Family in America
Volume 1**

**Compiled by
Mark L. Petersen
2008/2009**

Section III a. –Snyder Lineage Pedigrees A - H

The Snyder Family History, all direct line relatives back to the Colonies

A 1-2

A-Gen

B-Gen

C-Gen

D-Gen



Immigrated to America

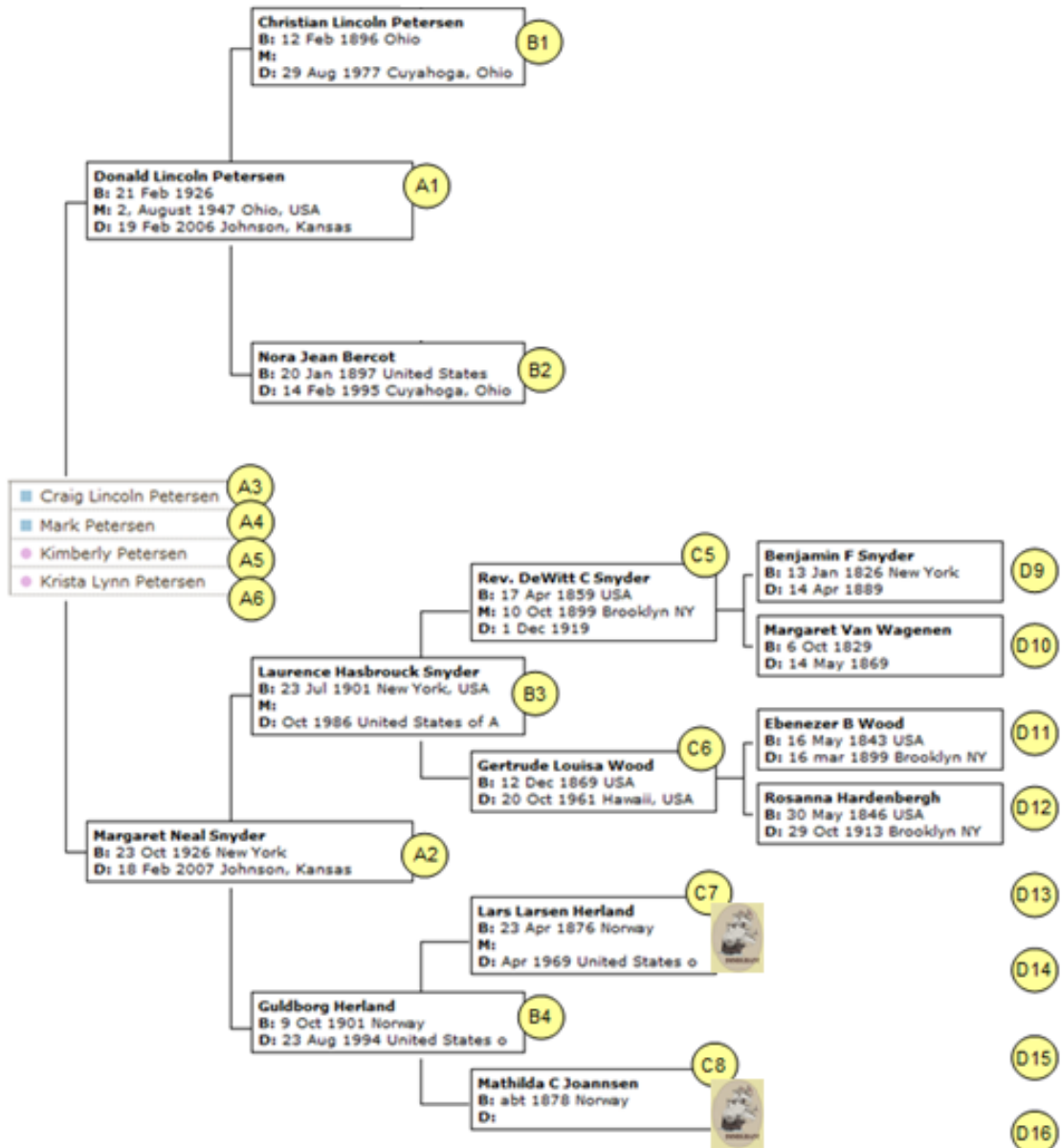

Snyder lines; D9-Snyder, D10-Van Wagenen, D11-Wood and D12-Hardenbergh go to the early 1600's through the early 1700's

The Snyder Family History, all direct line relatives back to the Colonies

D9

D-Gen E-Gen F-Gen G-Gen H-Gen

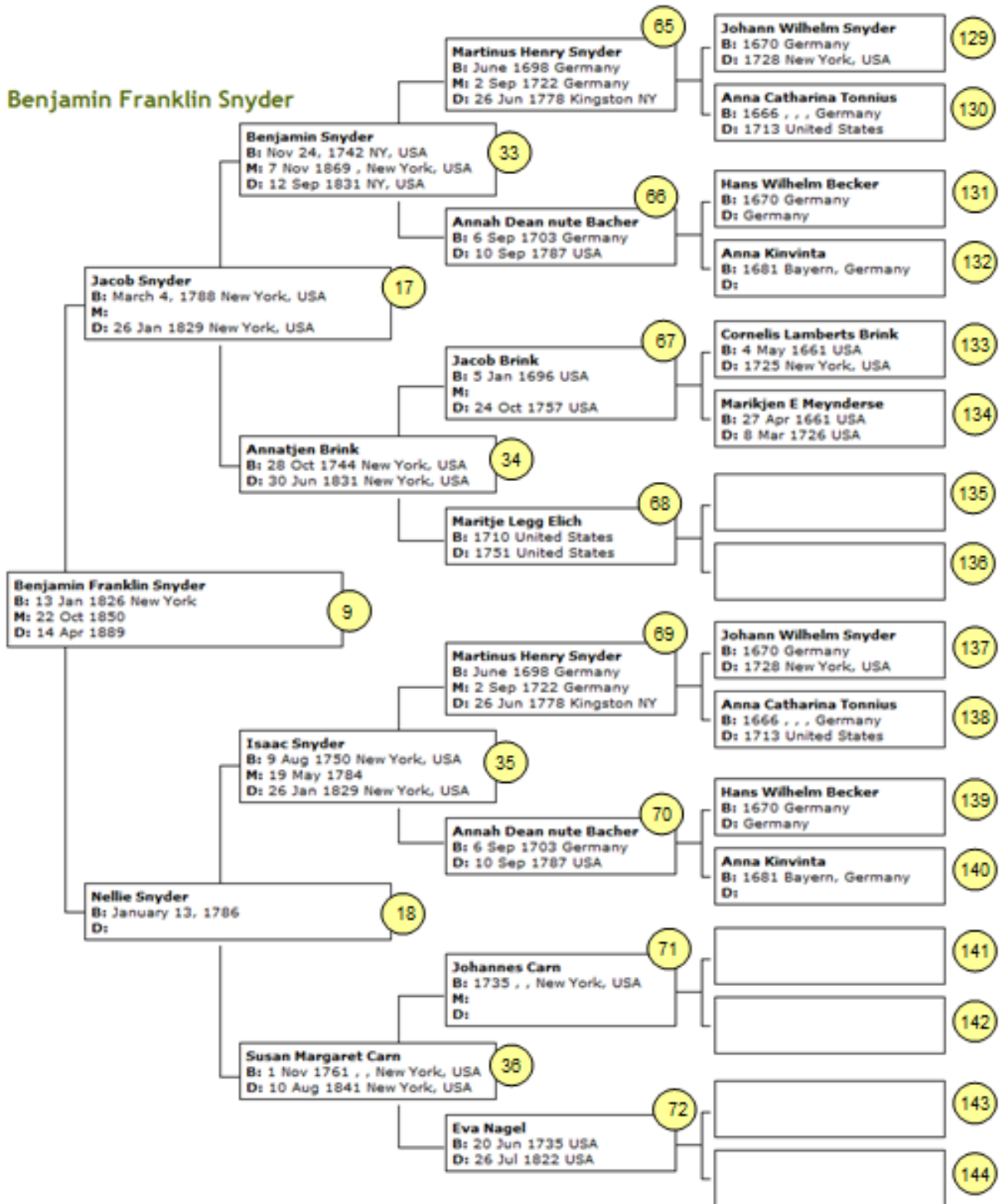

The Snyder Family History, all direct line relatives back to the Colonies

D10

D-Gen E-Gen F-Gen G-Gen H-Gen

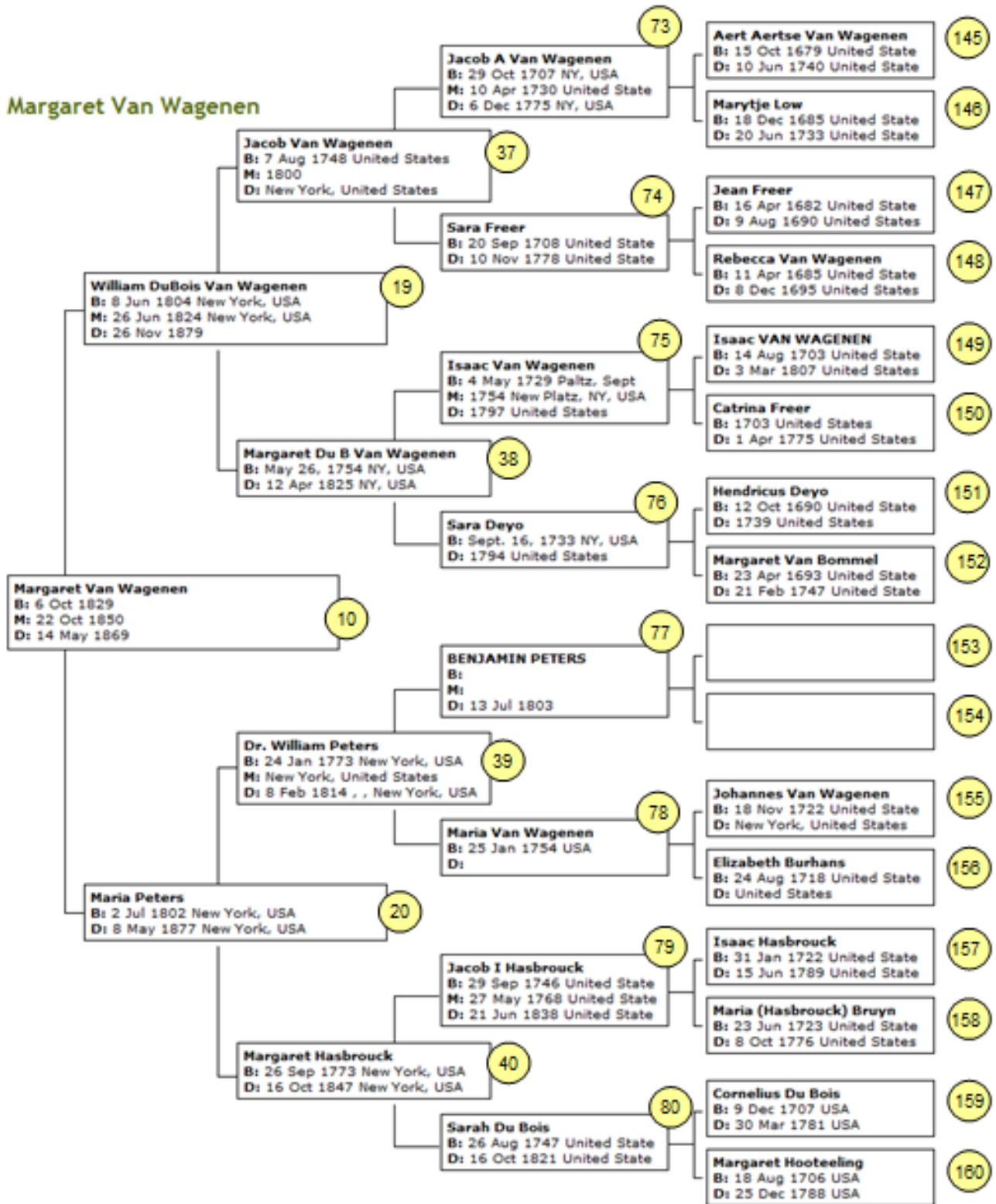

The Snyder Family History, all direct line relatives back to the Colonies

D11

D-Gen

E-Gen

F-Gen

G-Gen

H-Gen

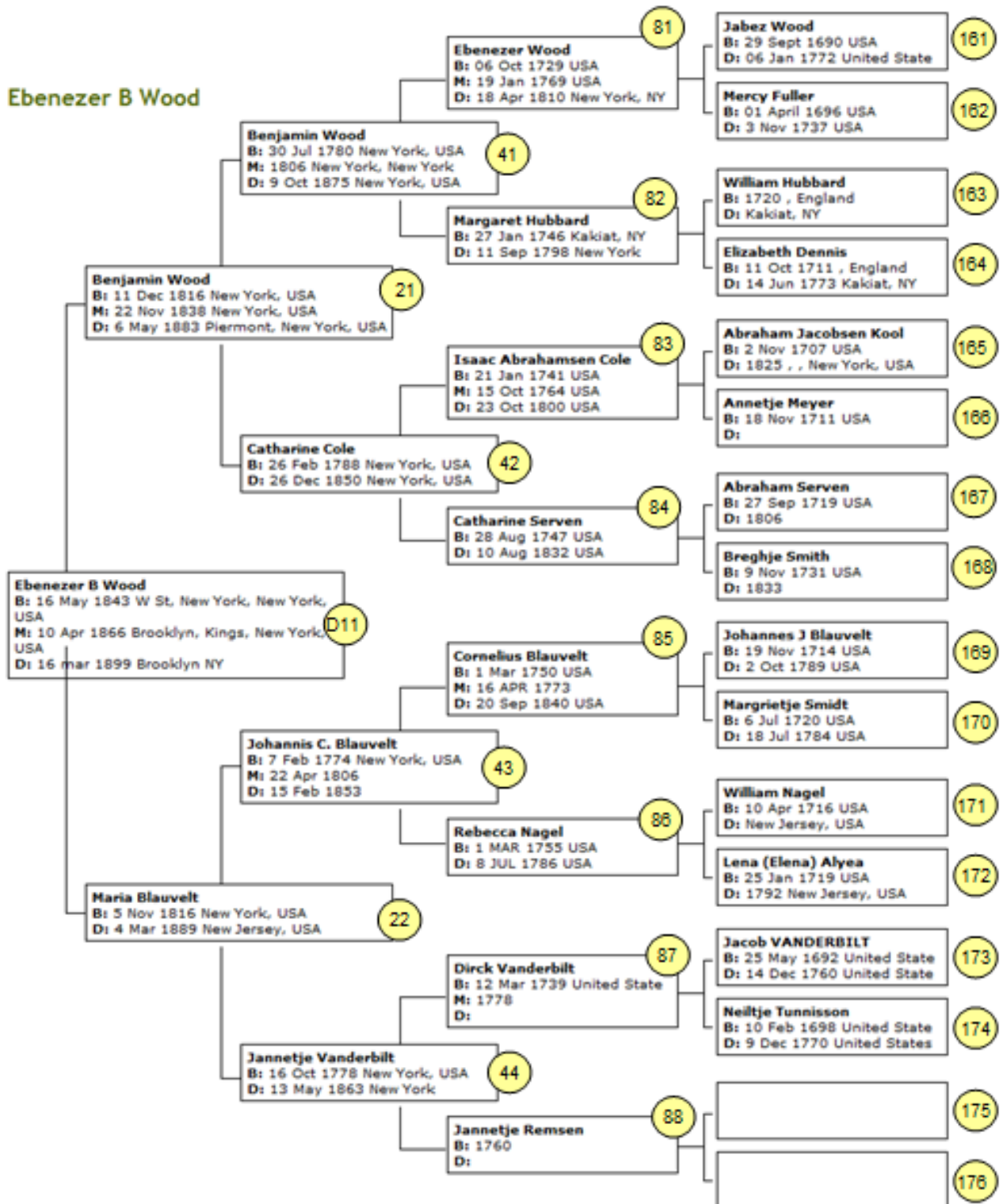

The Snyder Family History, all direct line relatives back to the Colonies

D12

D-Gen E-Gen F-Gen G-Gen H-Gen

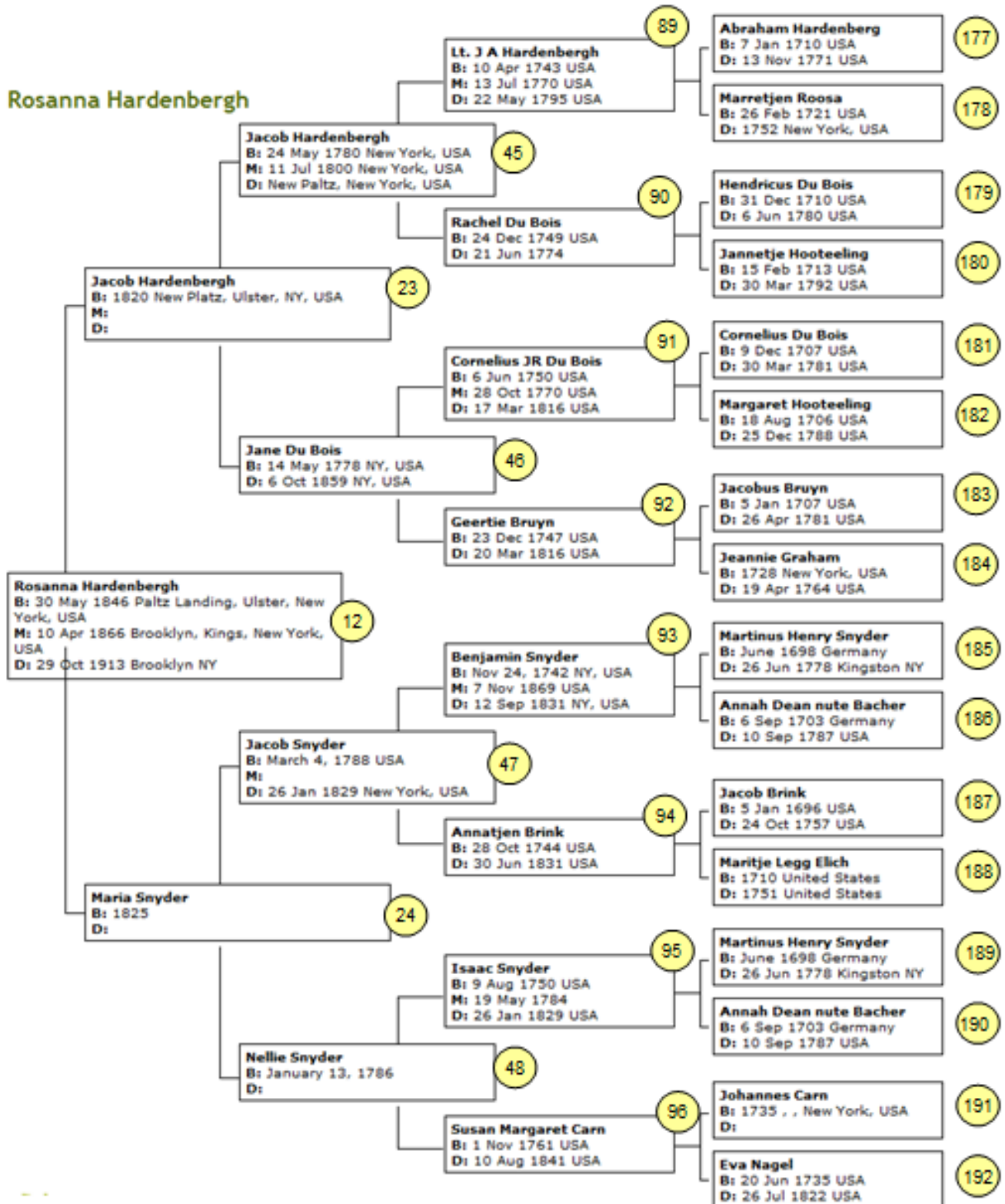

**The Petersen / Snyder Family in America
Volume 1**

Compiled by
Mark L. Petersen
2008/2009

Section III b. –Snyder Lineage H- M Pedigrees

The following pedigrees start with the H generation. The previous Pedigrees end with the H Generation. Use the previous Pedigree to follow our line to the early immigrants to the Colonies.

The Snyder Family History, all direct line relatives back to the Colonies

H133

H-Gen I-Gen J-Gen K-Gen L-Gen

Cornelis Lamberts Brink

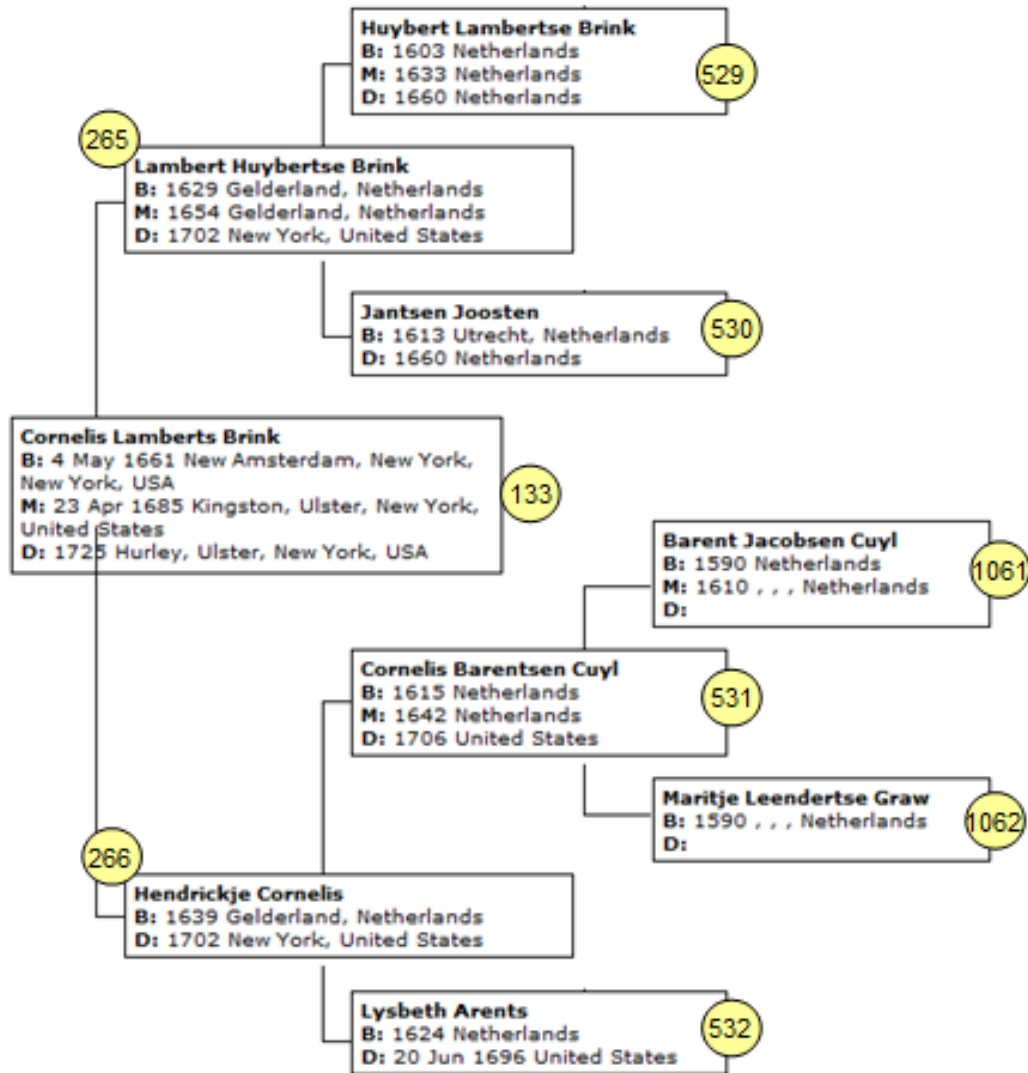

The Snyder Family History, all direct line relatives back to the Colonies

H134

H-Gen I-Gen J-Gen K-Gen L-Gen

Marikjen Egbertse Meynderse

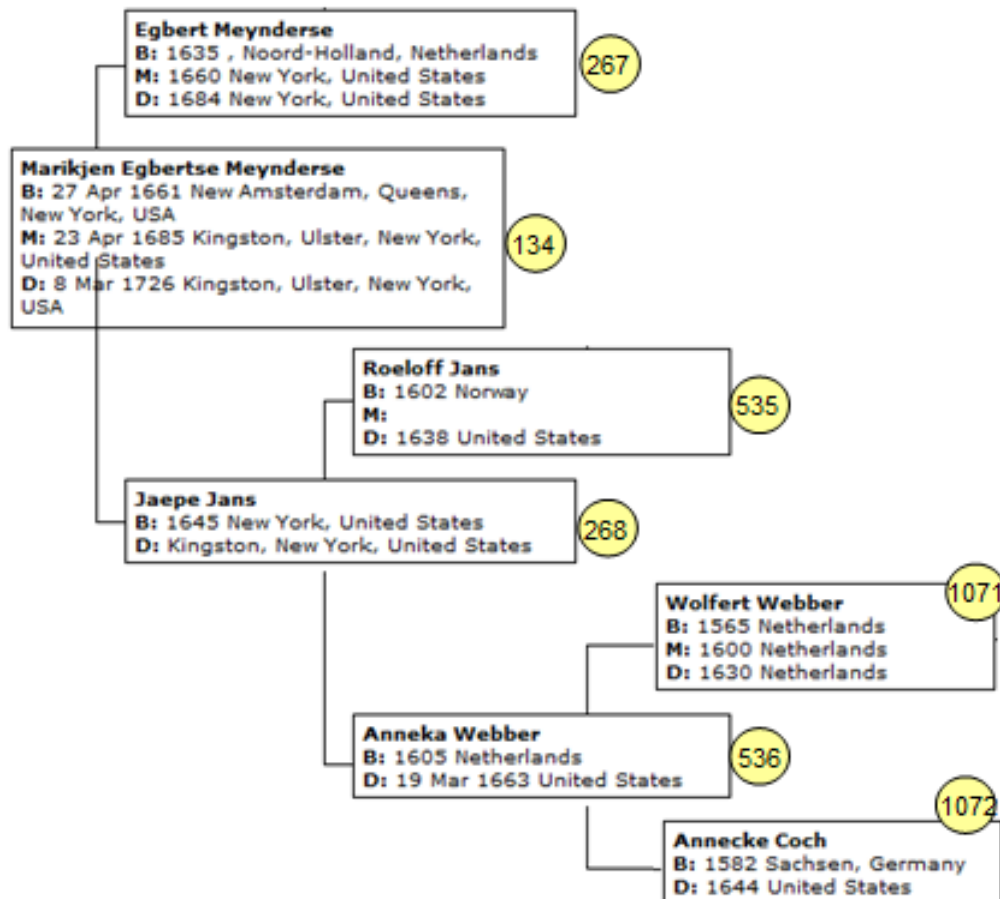

The Snyder Family History, all direct line relatives back to the Colonies

H145

H-Gen I-Gen J-Gen K-Gen L-Gen

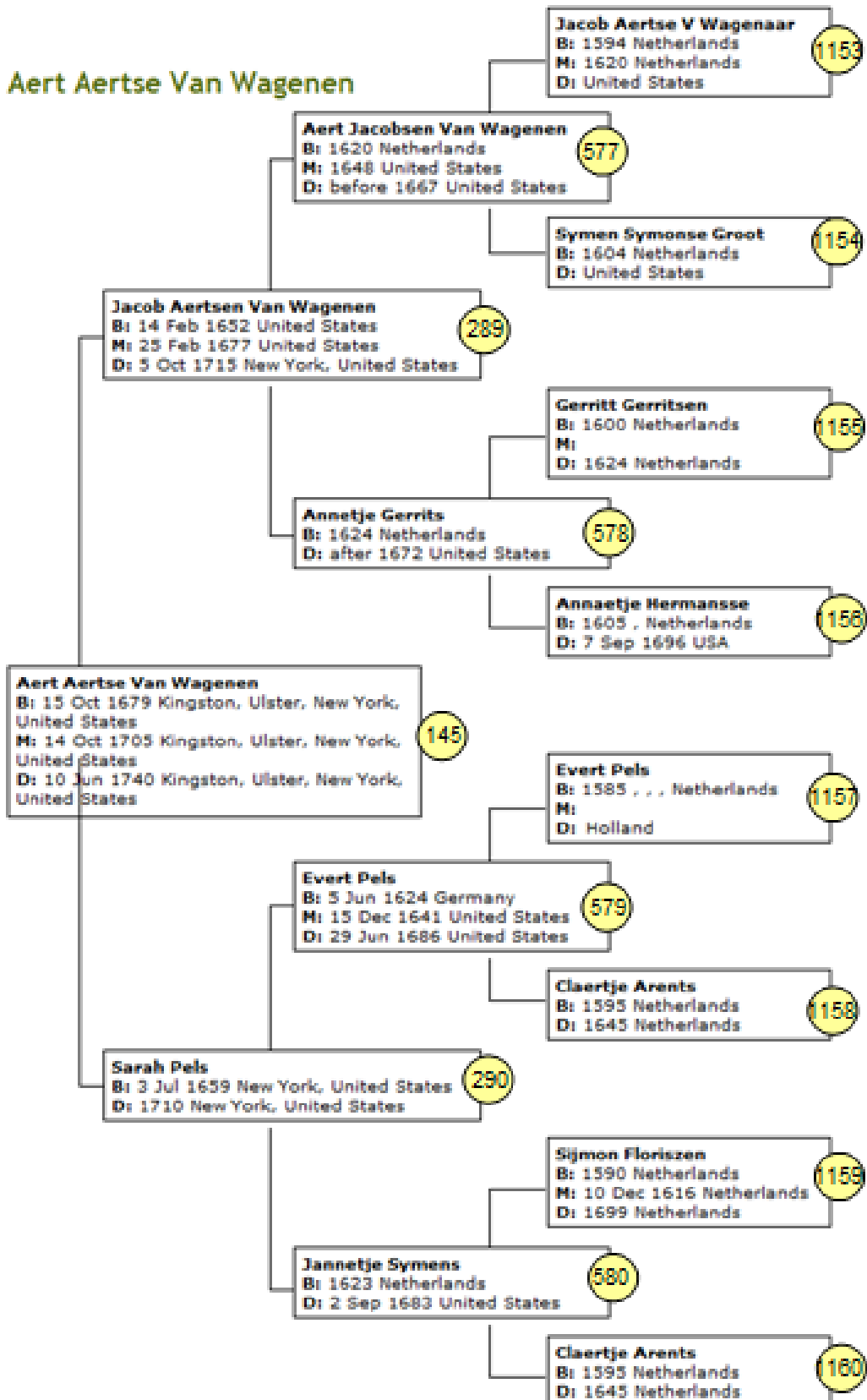

The Snyder Family History, all direct line relatives back to the Colonies

H146

H-Gen I-Gen J-Gen K-Gen L-Gen

Marytje Low

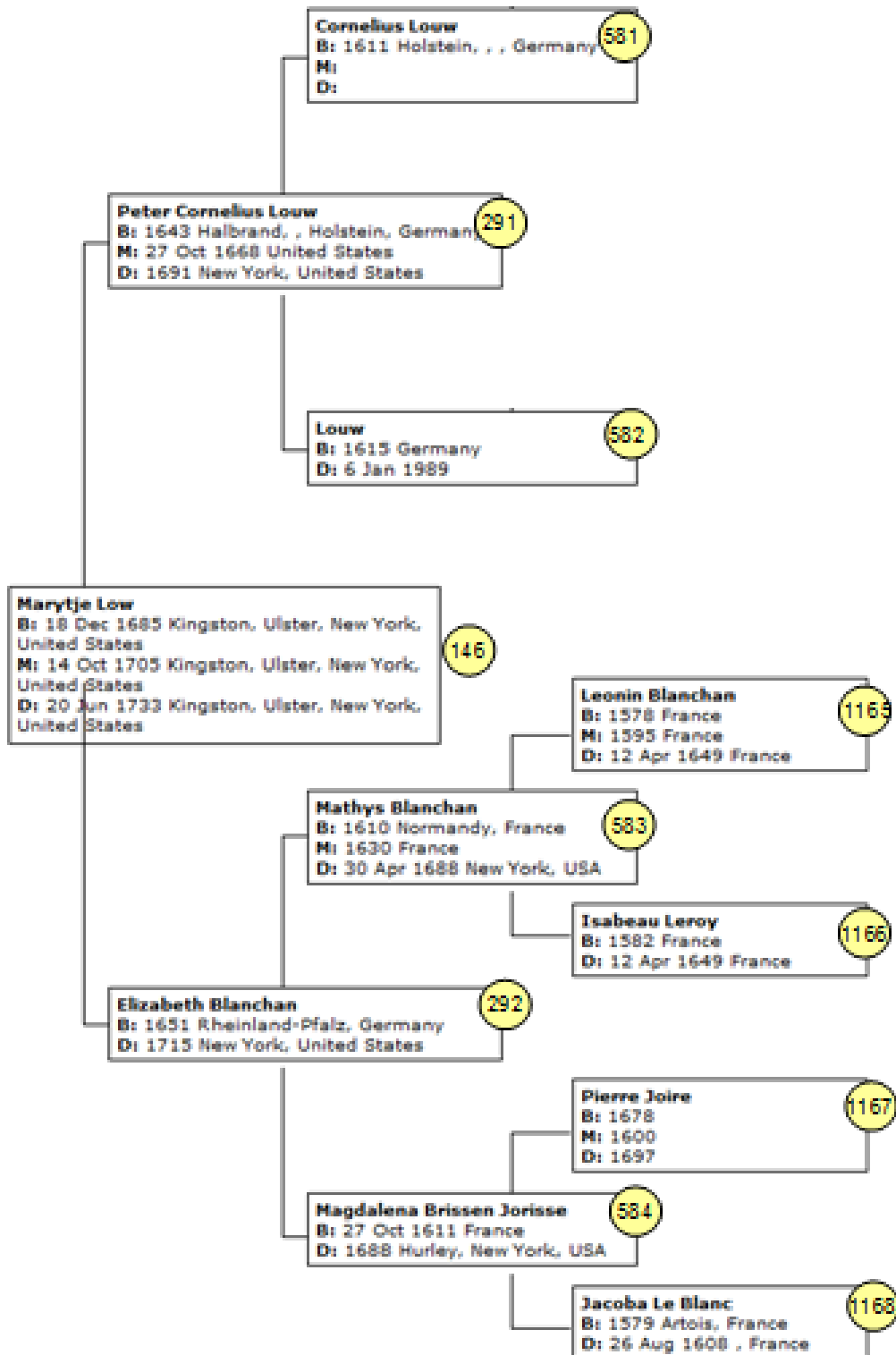

The Snyder Family History, all direct line relatives back to the Colonies

H147

H-Gen I-Gen

Jean Freer

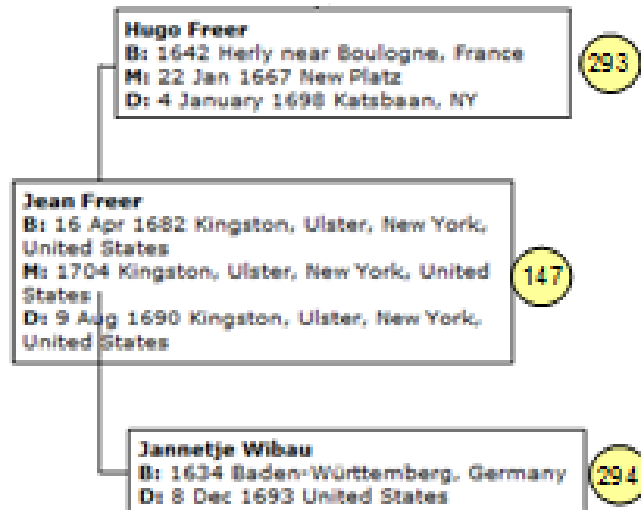

The Snyder Family History, all direct line relatives back to the Colonies

H148

H-Gen I-Gen J-Gen K-Gen L-Gen

Rebecca Van Wagenen

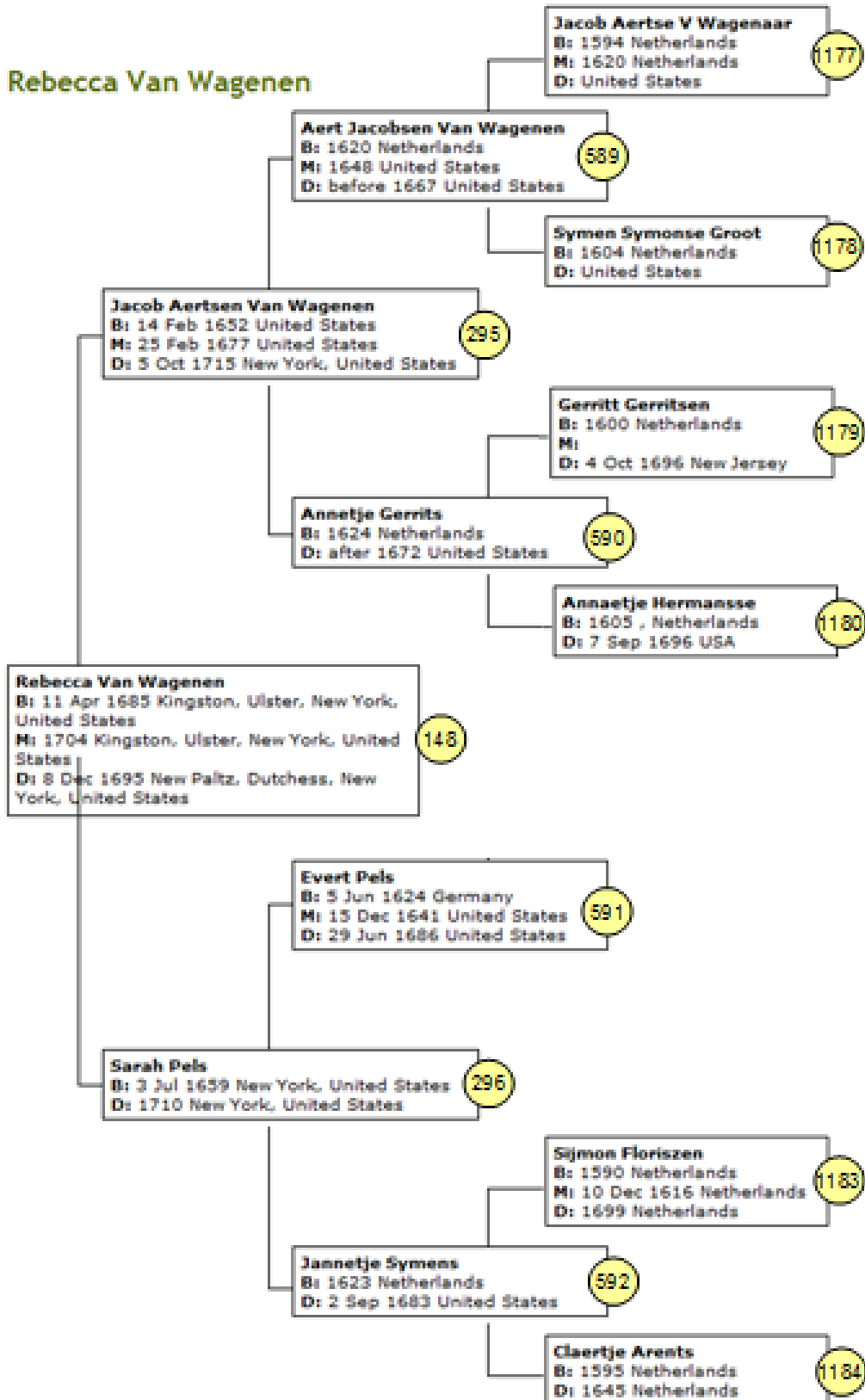

The Snyder Family History, all direct line relatives back to the Colonies

H149

H-Gen I-Gen J-Gen K-Gen L-Gen

Isaac VAN WAGENEN

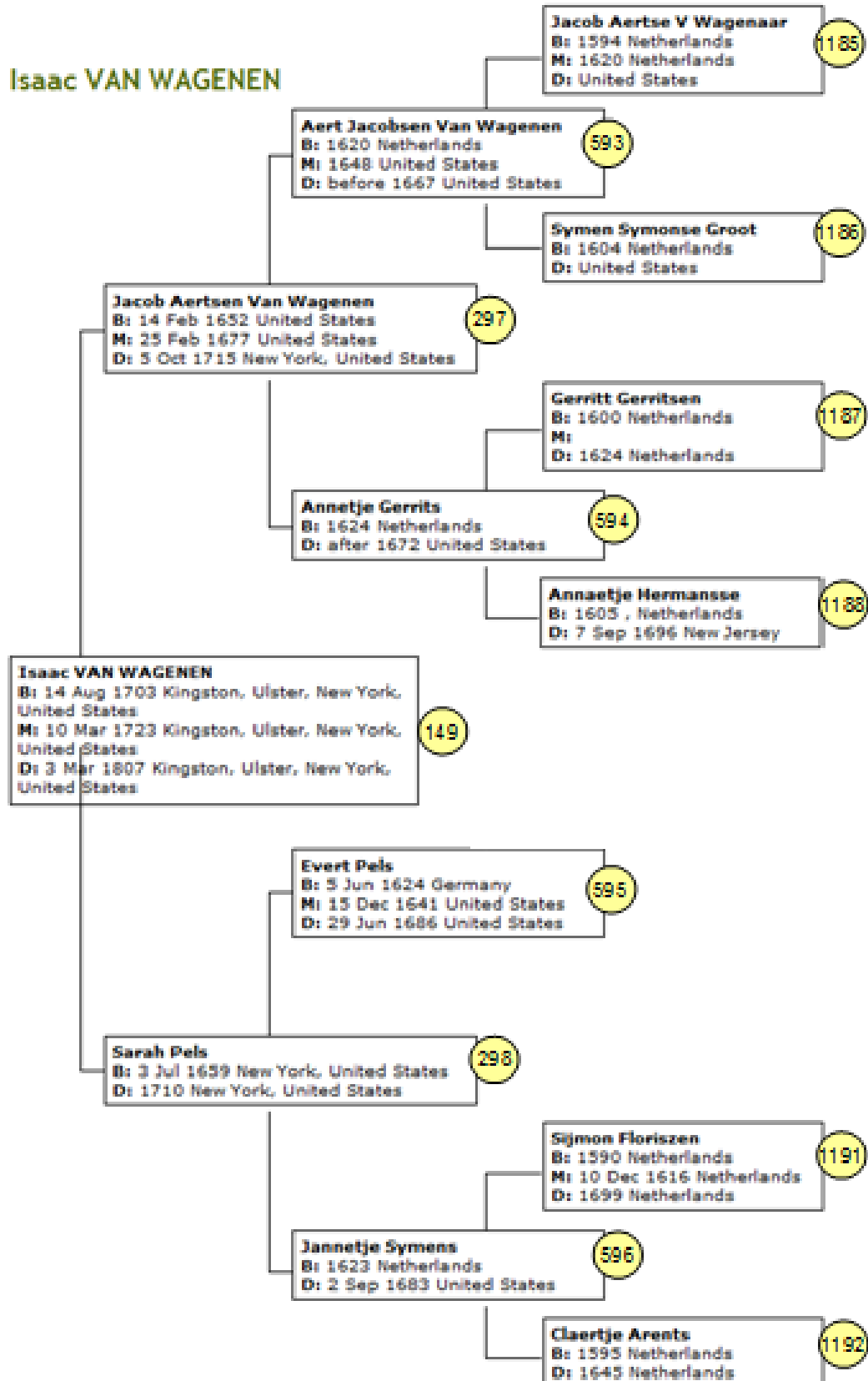

The Snyder Family History, all direct line relatives back to the Colonies

H150

H-Gen I-Gen J-Gen K-Gen L-Gen

Catrina Freer

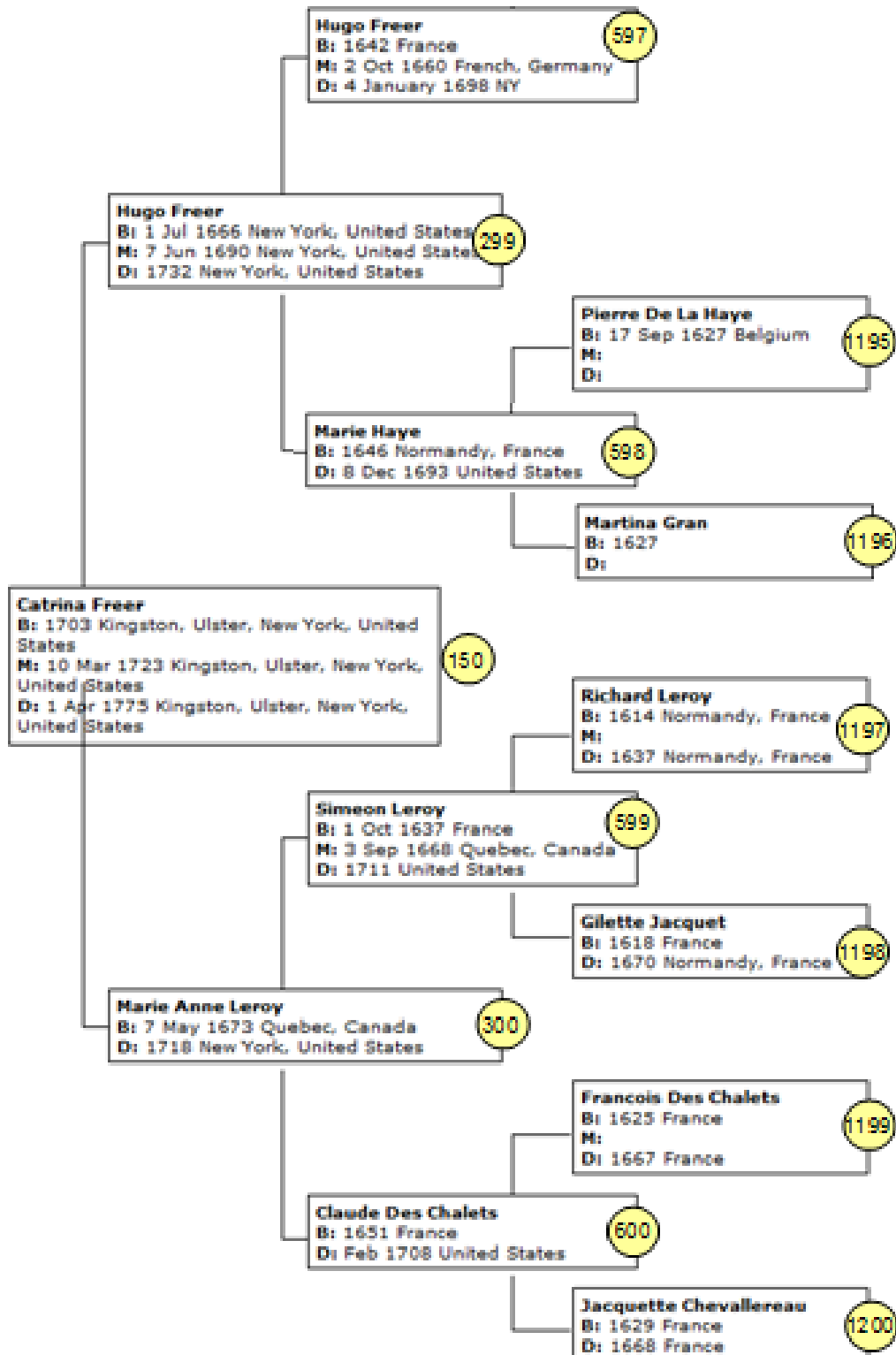

The Snyder Family History, all direct line relatives back to the Colonies

H151

H-Gen I-Gen J-Gen K-Gen L-Gen

Hendricus Deyo

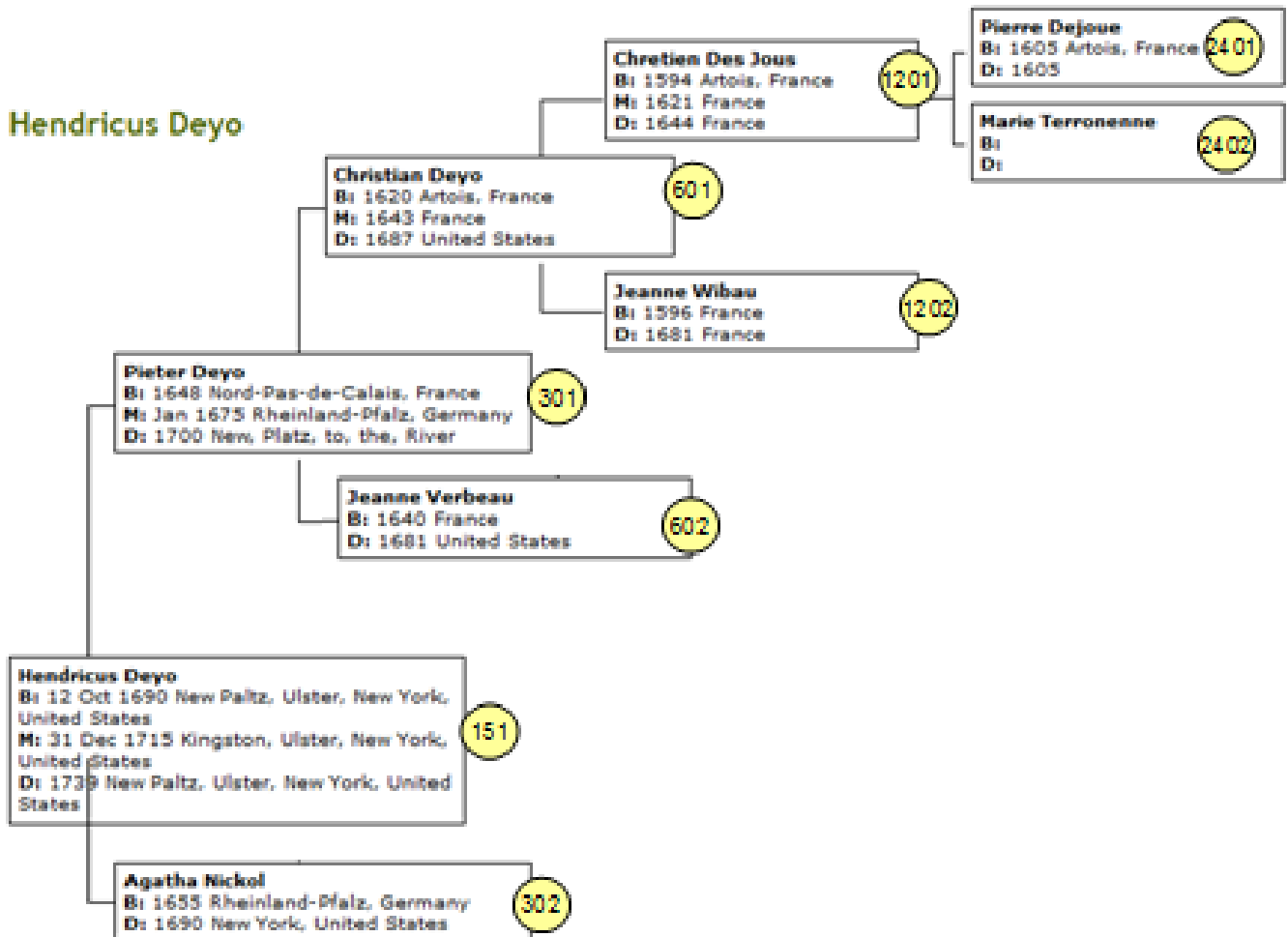

The Snyder Family History, all direct line relatives back to the Colonies

H152

H-Gen I-Gen J-Gen K-Gen L-Gen

Margaret Van Bommel

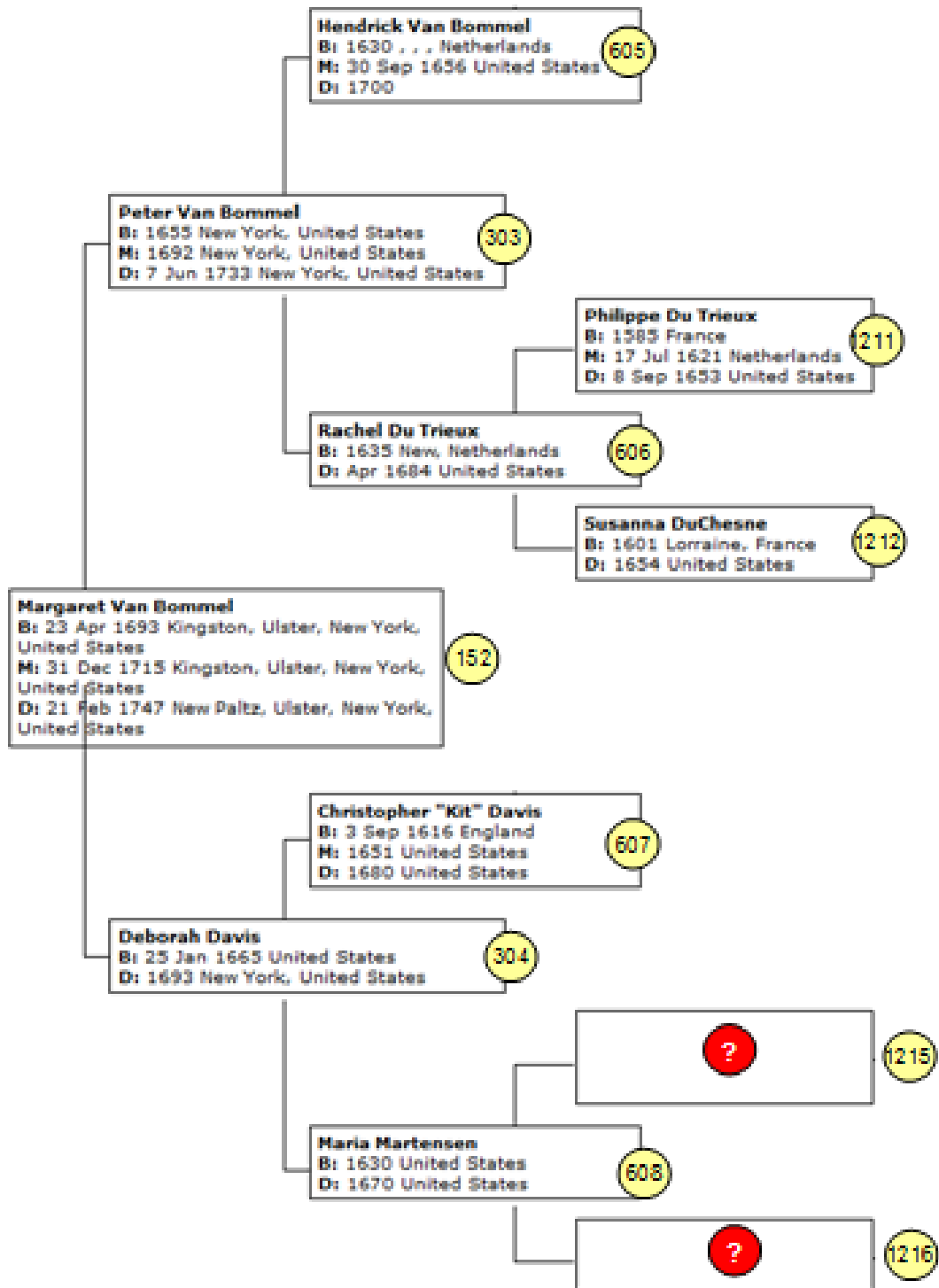

The Snyder Family History, all direct line relatives back to the Colonies

H155

H-Gen I-Gen J-Gen K-Gen L-Gen

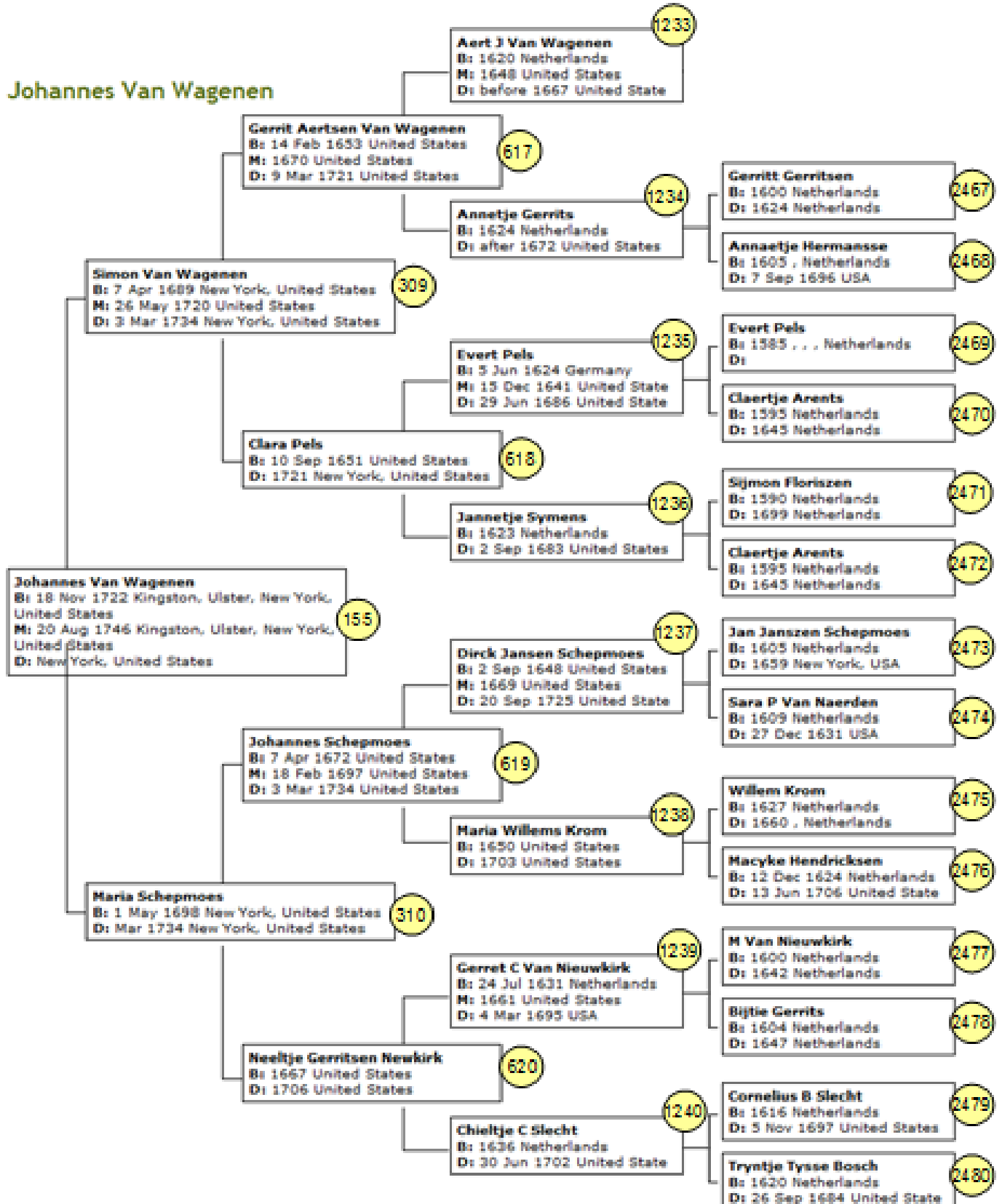

The Snyder Family History, all direct line relatives back to the Colonies

H156

H-Gen I-Gen J-Gen K-Gen L-Gen

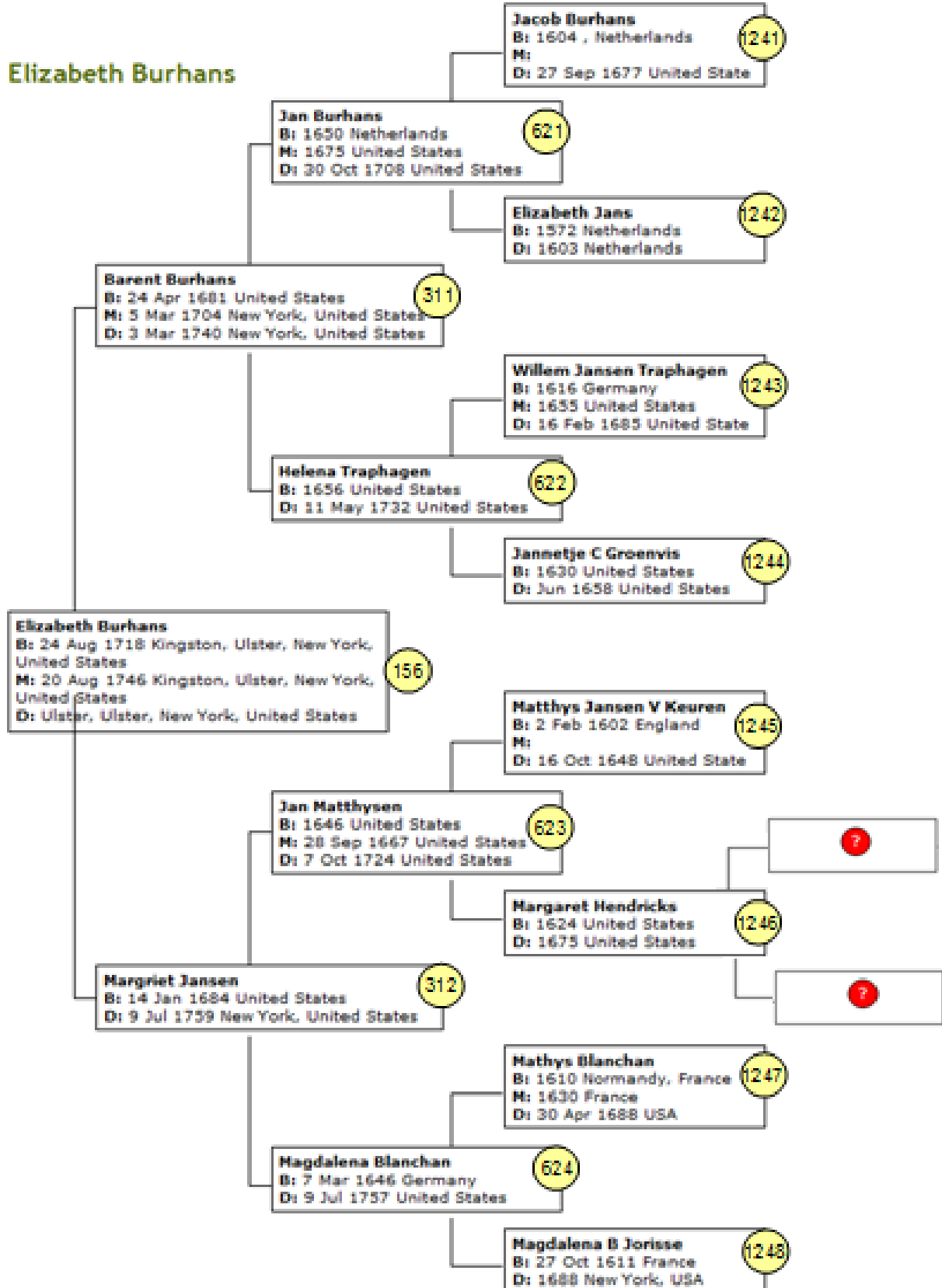

The Snyder Family History, all direct line relatives back to the Colonies

H157

H-Gen I-Gen J-Gen K-Gen L-Gen

Isaac Hasbrouck

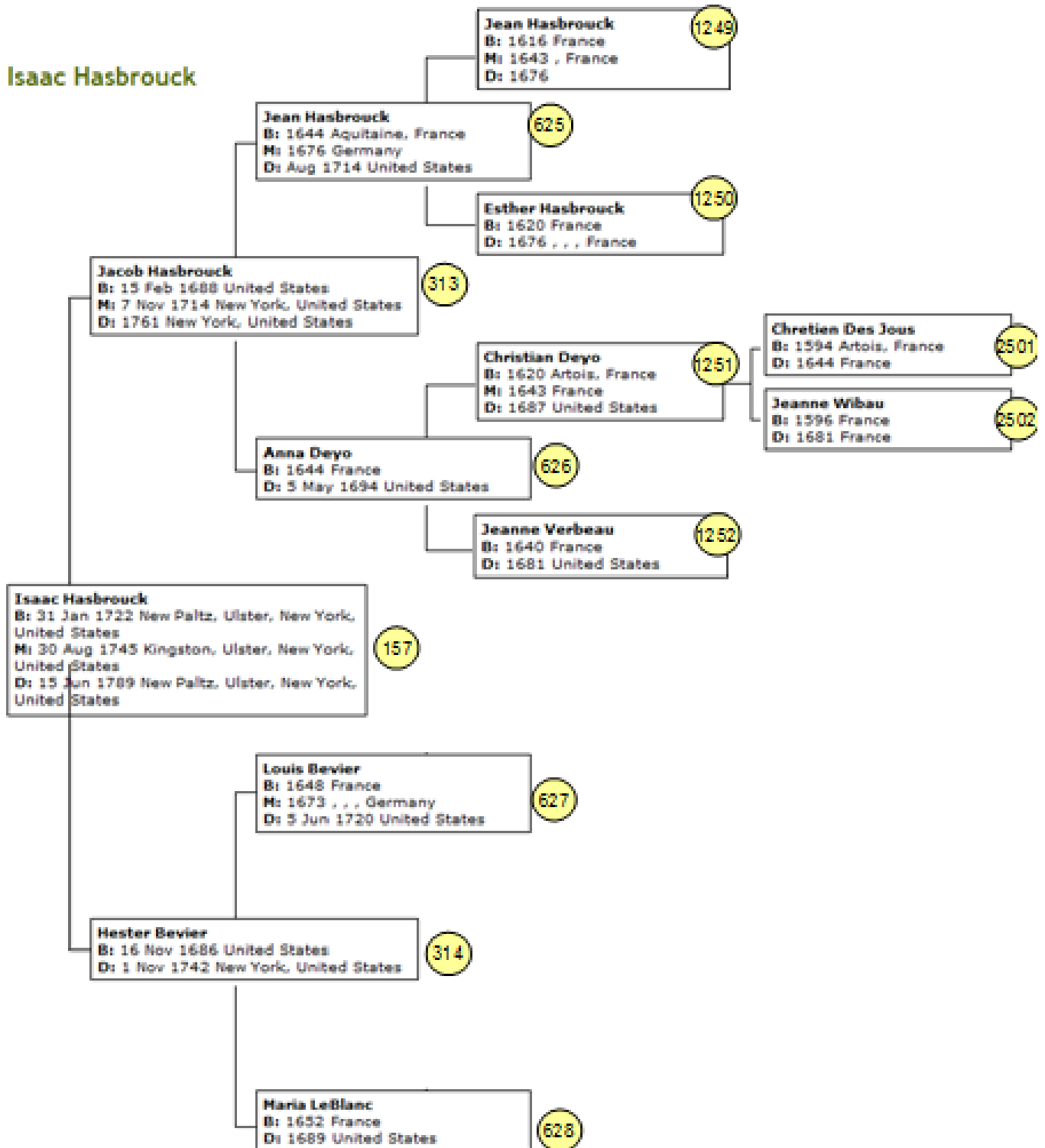

The Snyder Family History, all direct line relatives back to the Colonies

H158

H-Gen I-Gen J-Gen K-Gen L-Gen

Maria (Hasbrouck) Bruyn

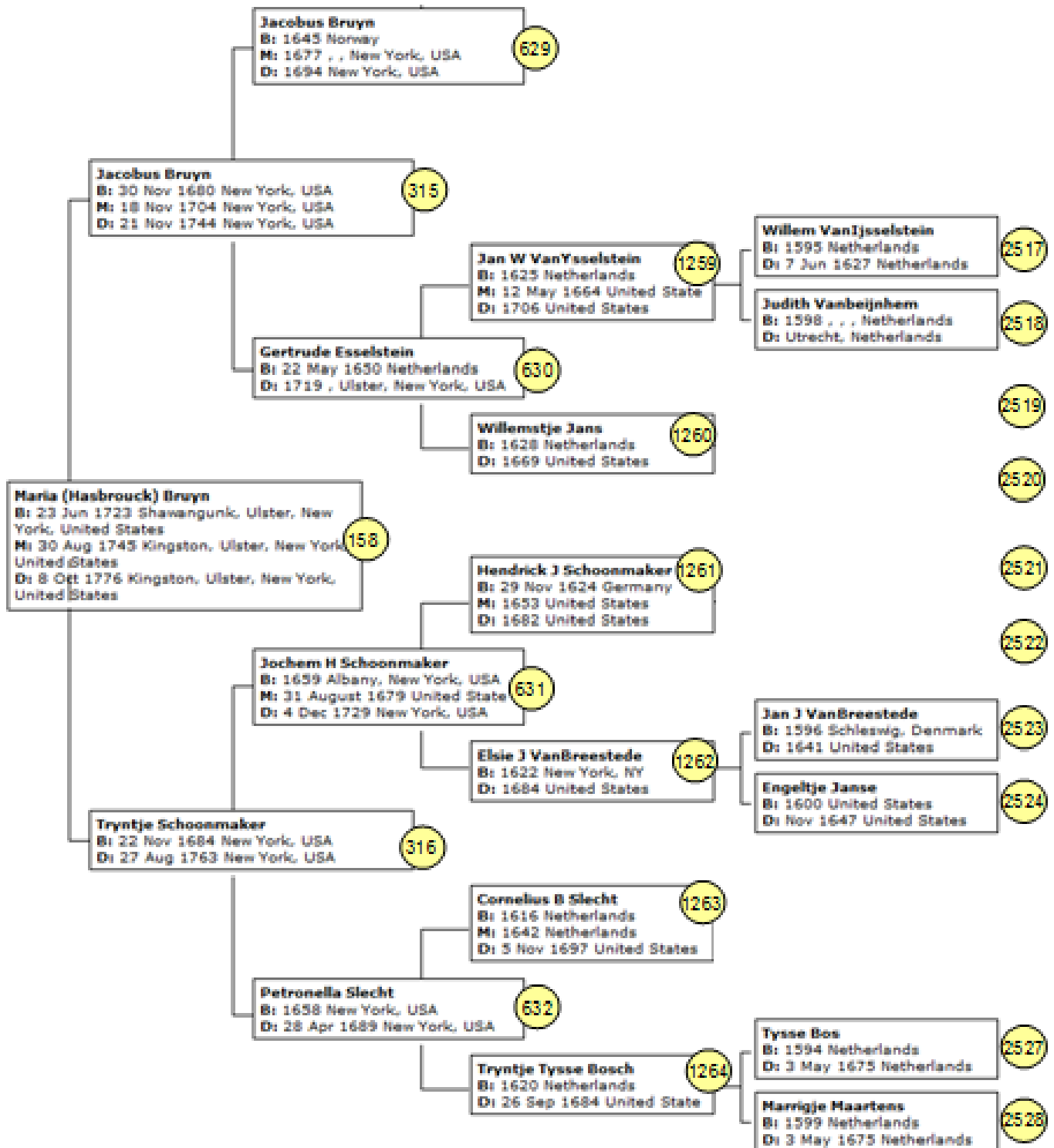

The Snyder Family History, all direct line relatives back to the Colonies

H159

H-Gen I-Gen J-Gen K-Gen L-Gen

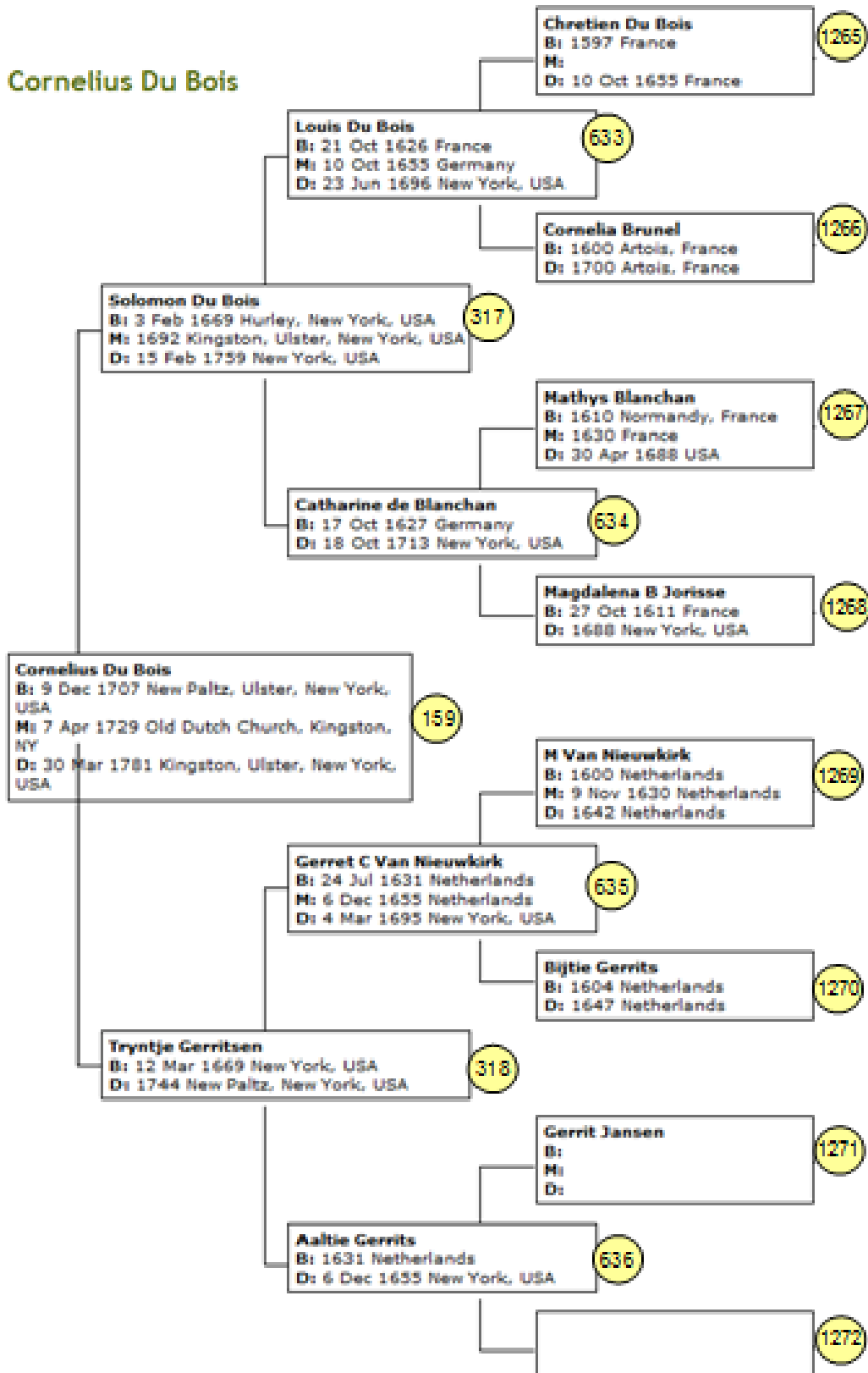

The Snyder Family History, all direct line relatives back to the Colonies

H160

H-Gen I-Gen J-Gen K-Gen L-Gen

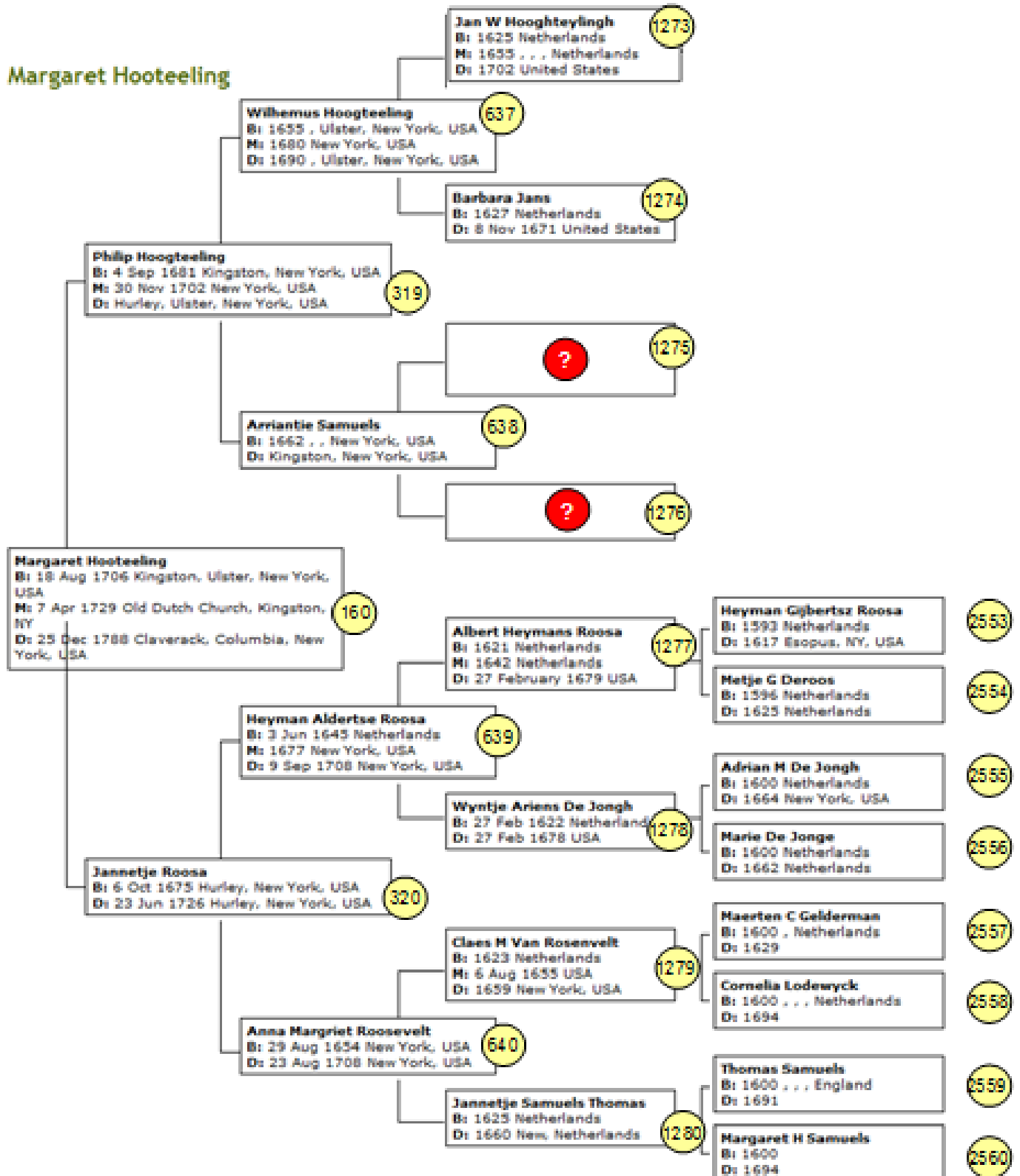

The Snyder Family History, all direct line relatives back to the Colonies

H161

H-Gen I-Gen J-Gen K-Gen L-Gen

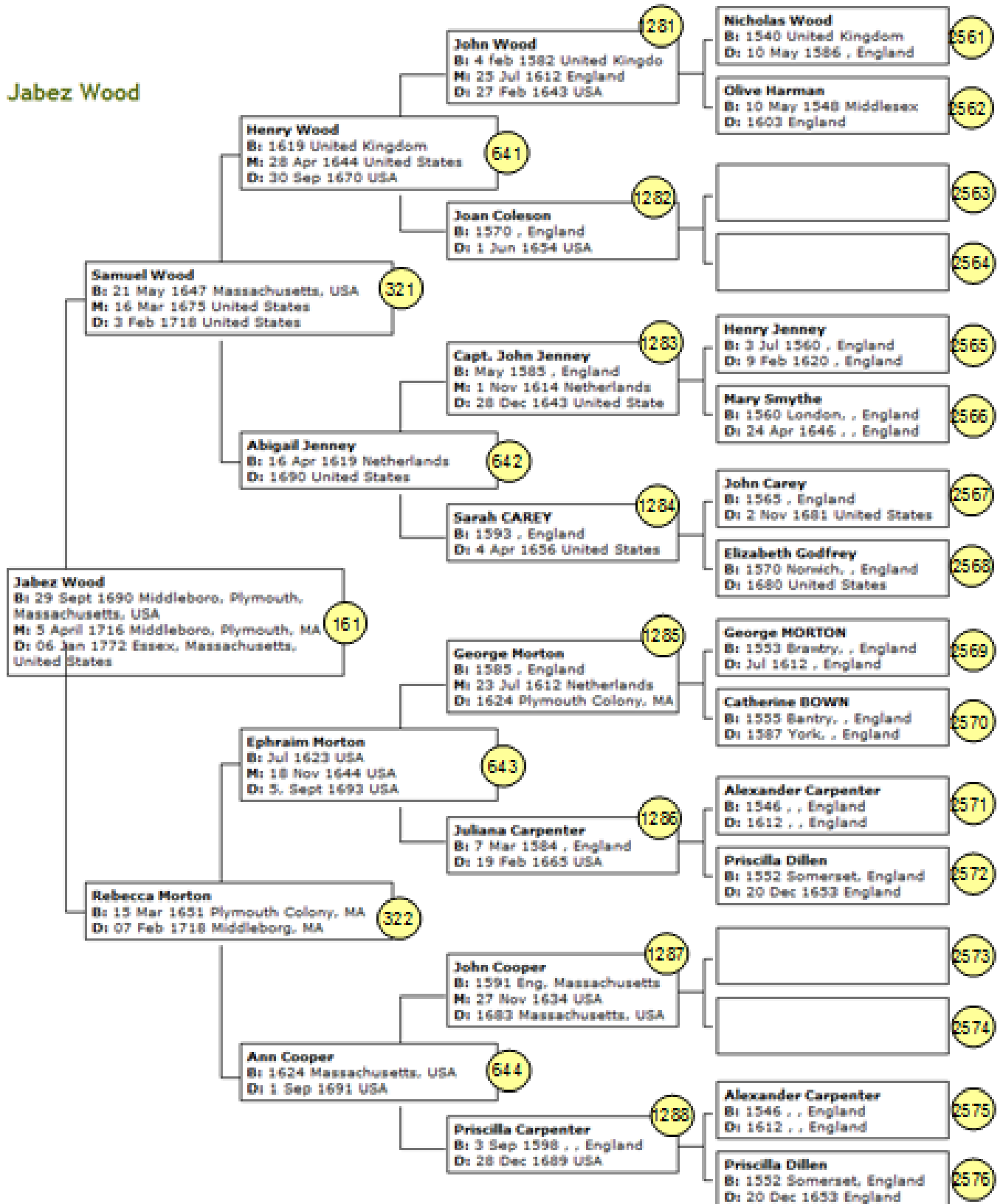

The Snyder Family History, all direct line relatives back to the Colonies

H162

H-Gen I-Gen J-Gen K-Gen L-Gen

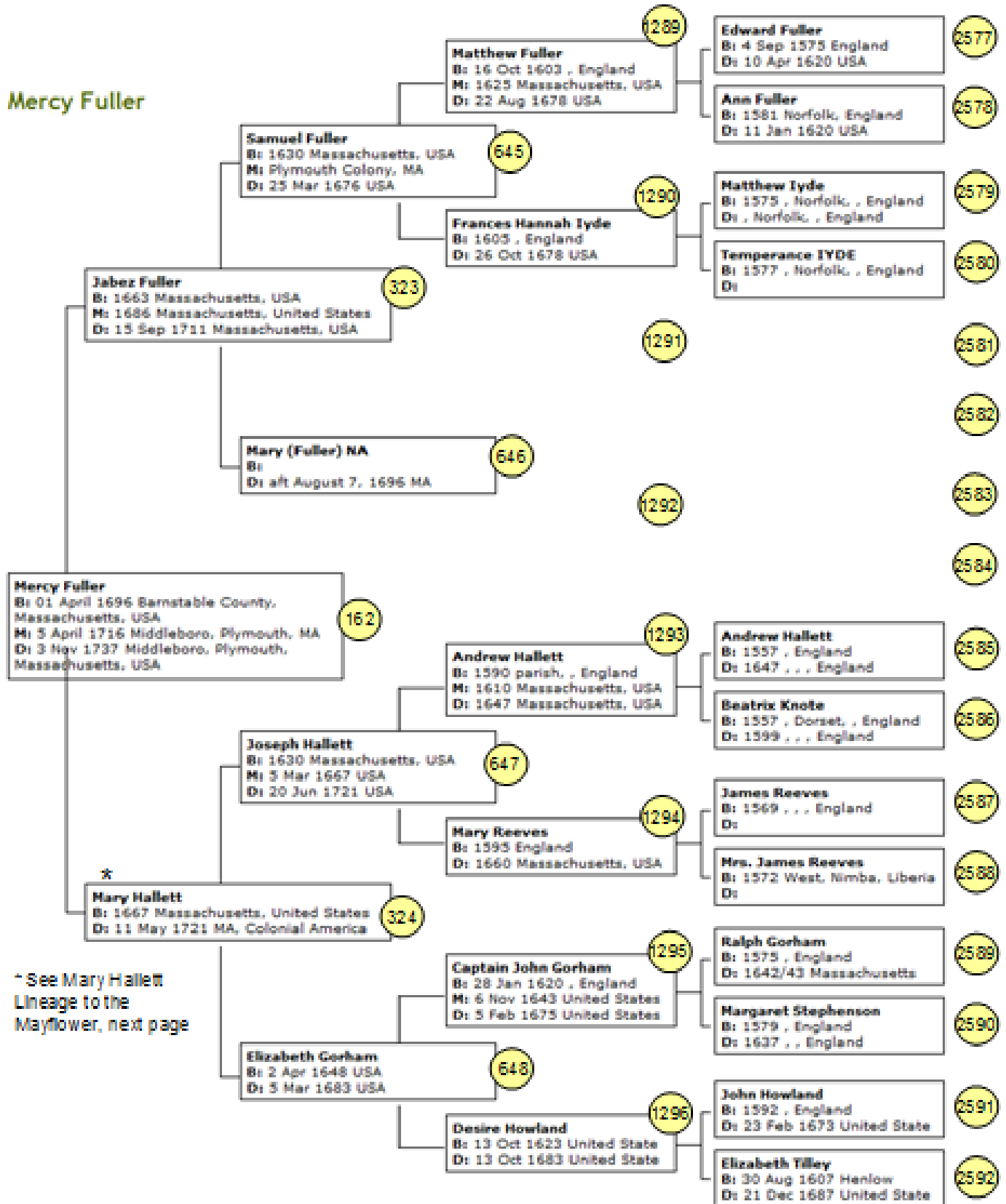

The Snyder Family History, all direct line relatives back to the Colonies

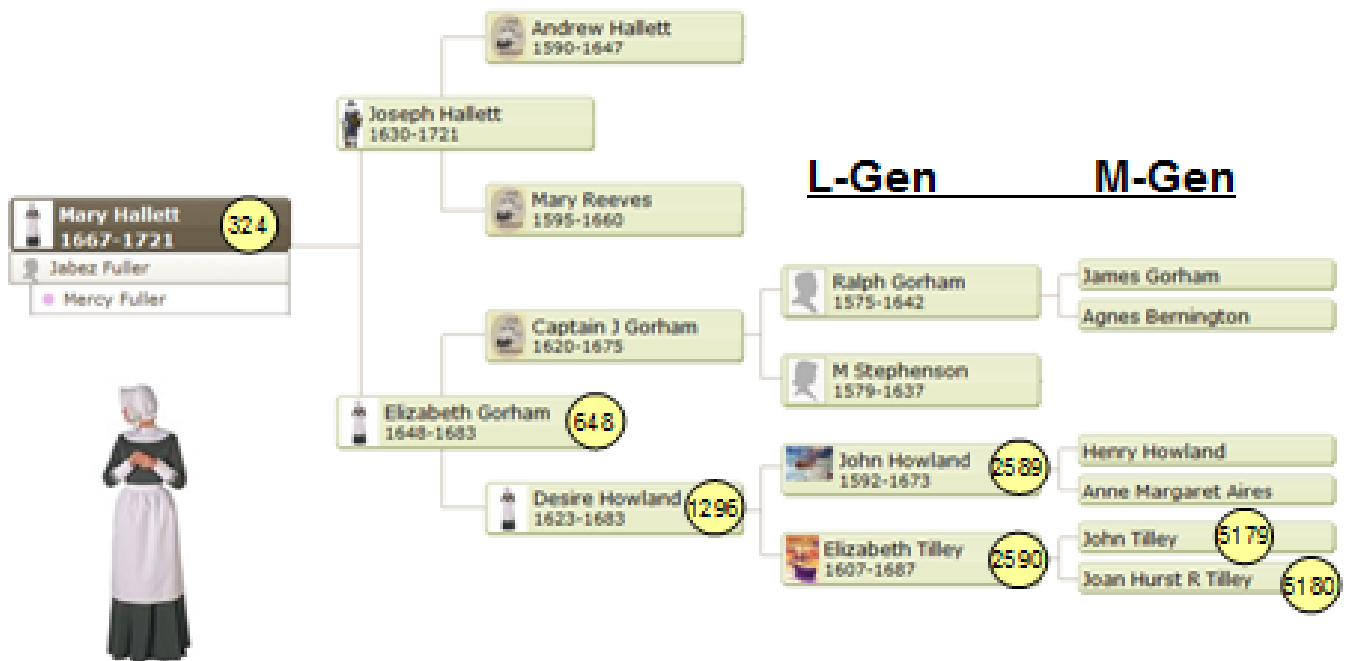

John Tilley and his wife Joan Hurst Rogers Tilley were passengers on the Mayflower, along with their daughter, (then unmarried) Elisabeth; John Howland and Edward and Ann Fuller – rounding out the 6 Mayflower passengers in our lineage

John Tilley and his wife Joan are in the ‘M’ Generation

The Snyder Family History, all direct line relatives back to the Colonies

H163

H-Gen I-Gen J-Gen K-Gen L-Gen

William Hubbard

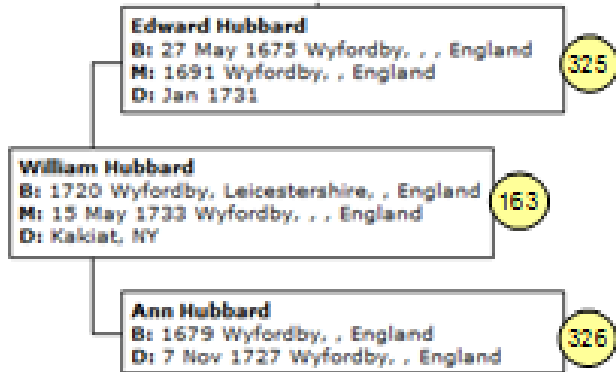

H164

H-Gen I-Gen J-Gen J-Gen K-Gen

Elizabeth Dennis

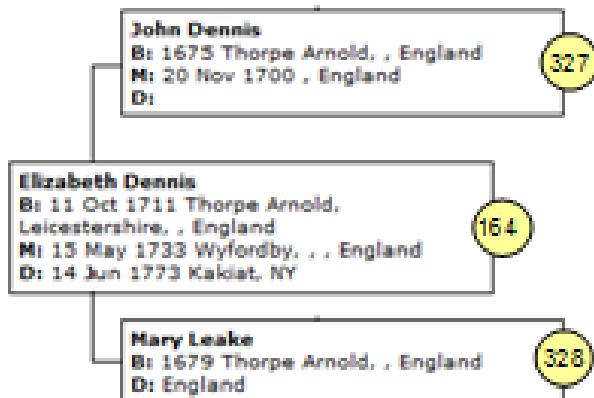

The Snyder Family History, all direct line relatives back to the Colonies

H165

H-Gen I-Gen J-Gen K-Gen L-Gen

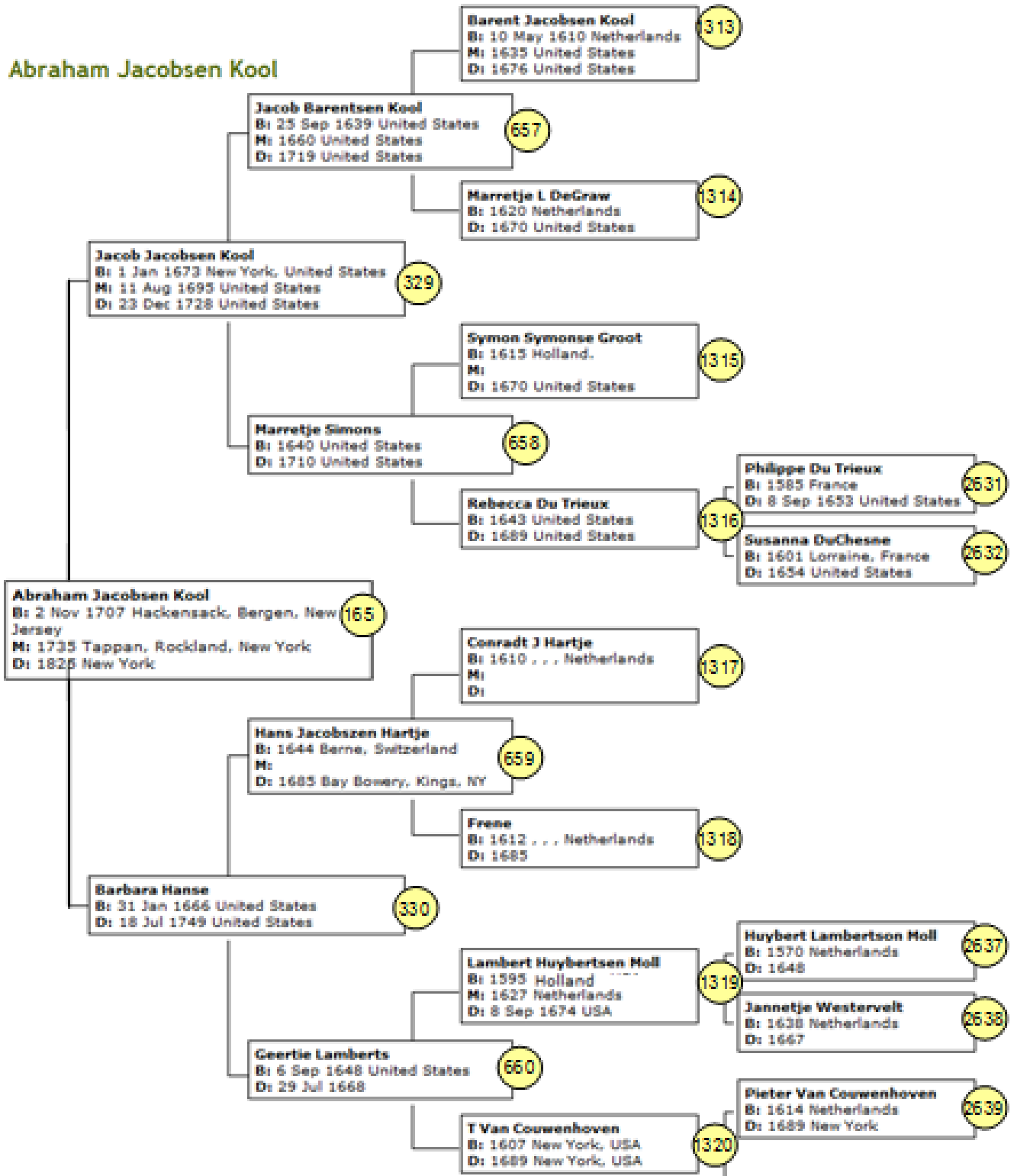

The Snyder Family History, all direct line relatives back to the Colonies

H166

H-Gen I-Gen J-Gen K-Gen L-Gen

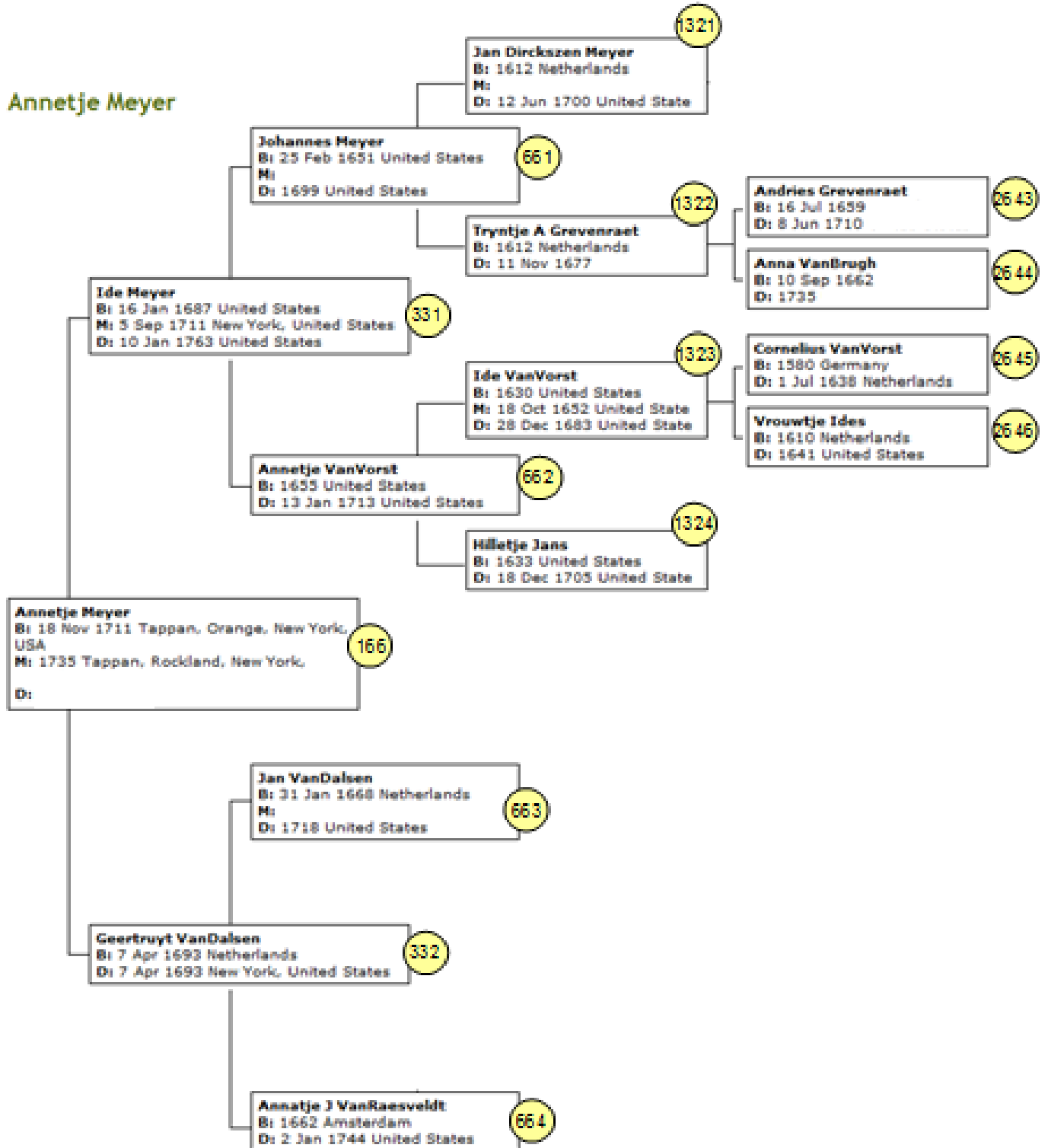

The Snyder Family History, all direct line relatives back to the Colonies

H167

H-Gen I-Gen J-Gen K-Gen L-Gen

Abraham Serven

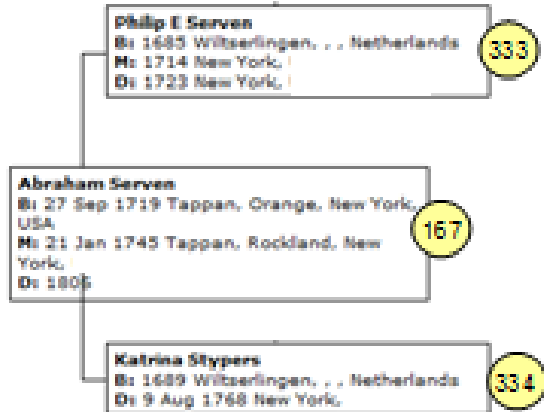

The Snyder Family History, all direct line relatives back to the Colonies

H168

H-Gen I-Gen J-Gen K-Gen L-Gen

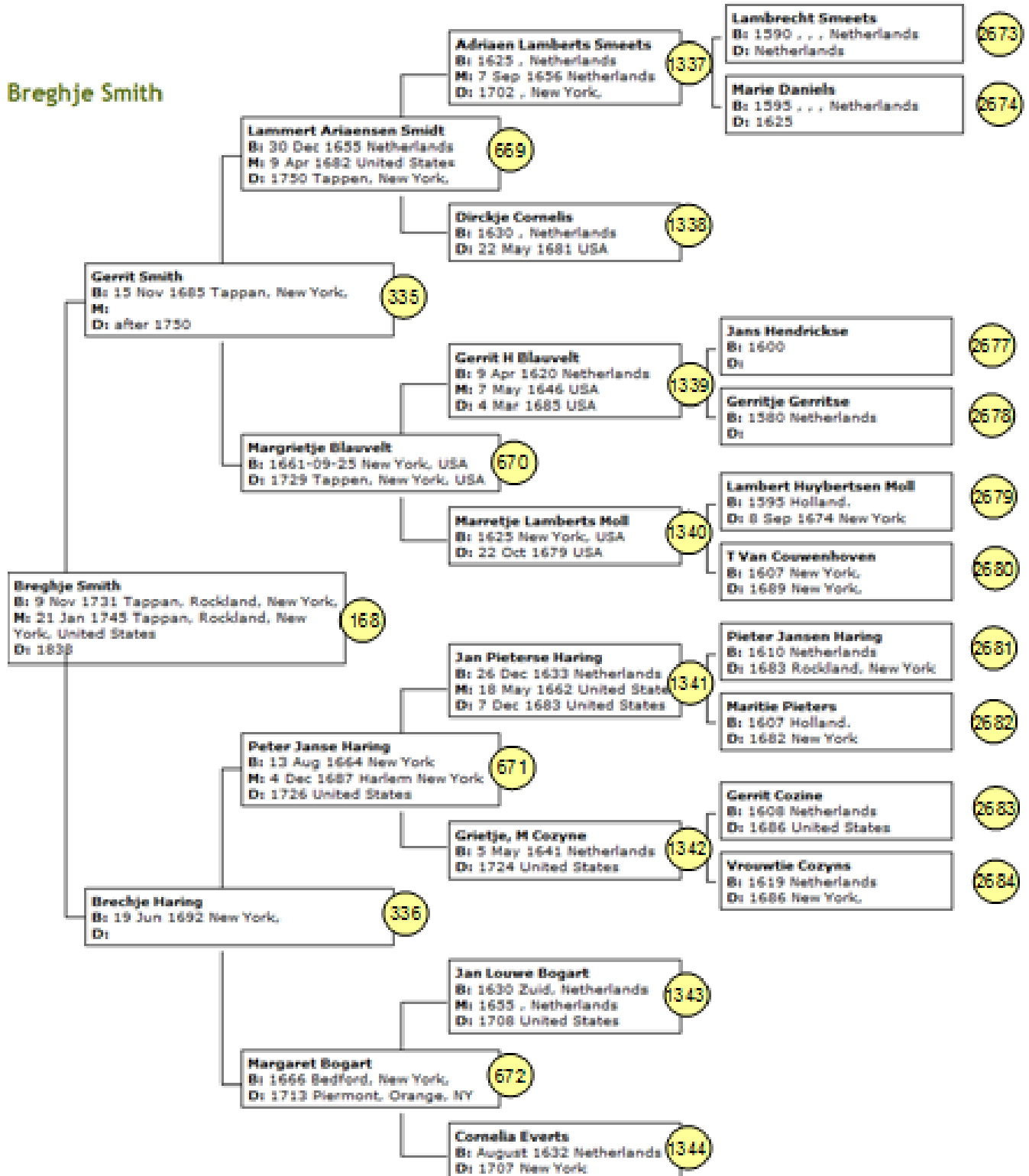

The Snyder Family History, all direct line relatives back to the Colonies

M 2680

L-Gen M-Gen N-Gen O-Gen

Tryntje Pieterse Van Couwenhoven

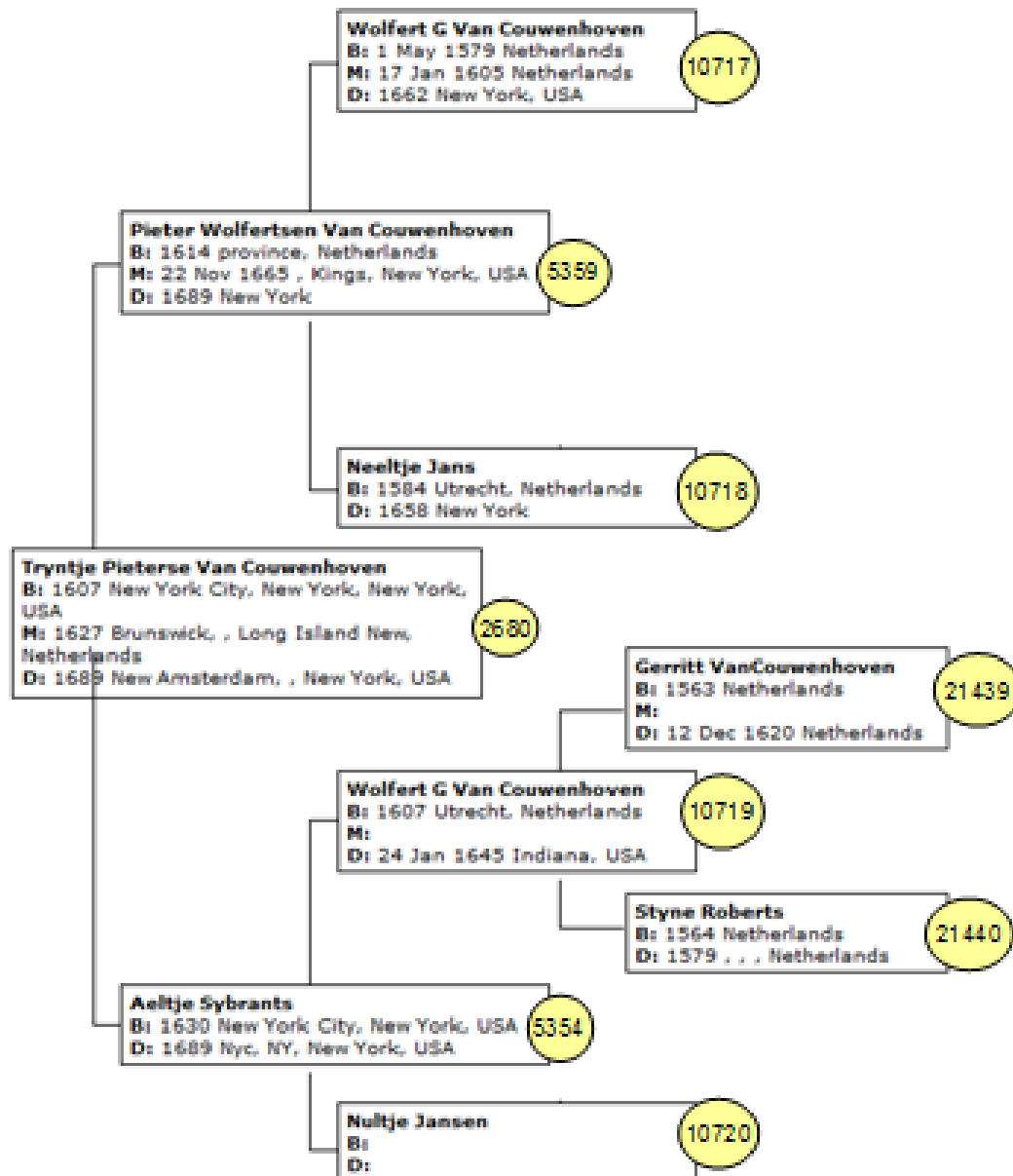

The Snyder Family History, all direct line relatives back to the Colonies

H169

H-Gen I-Gen J-Gen K-Gen L-Gen

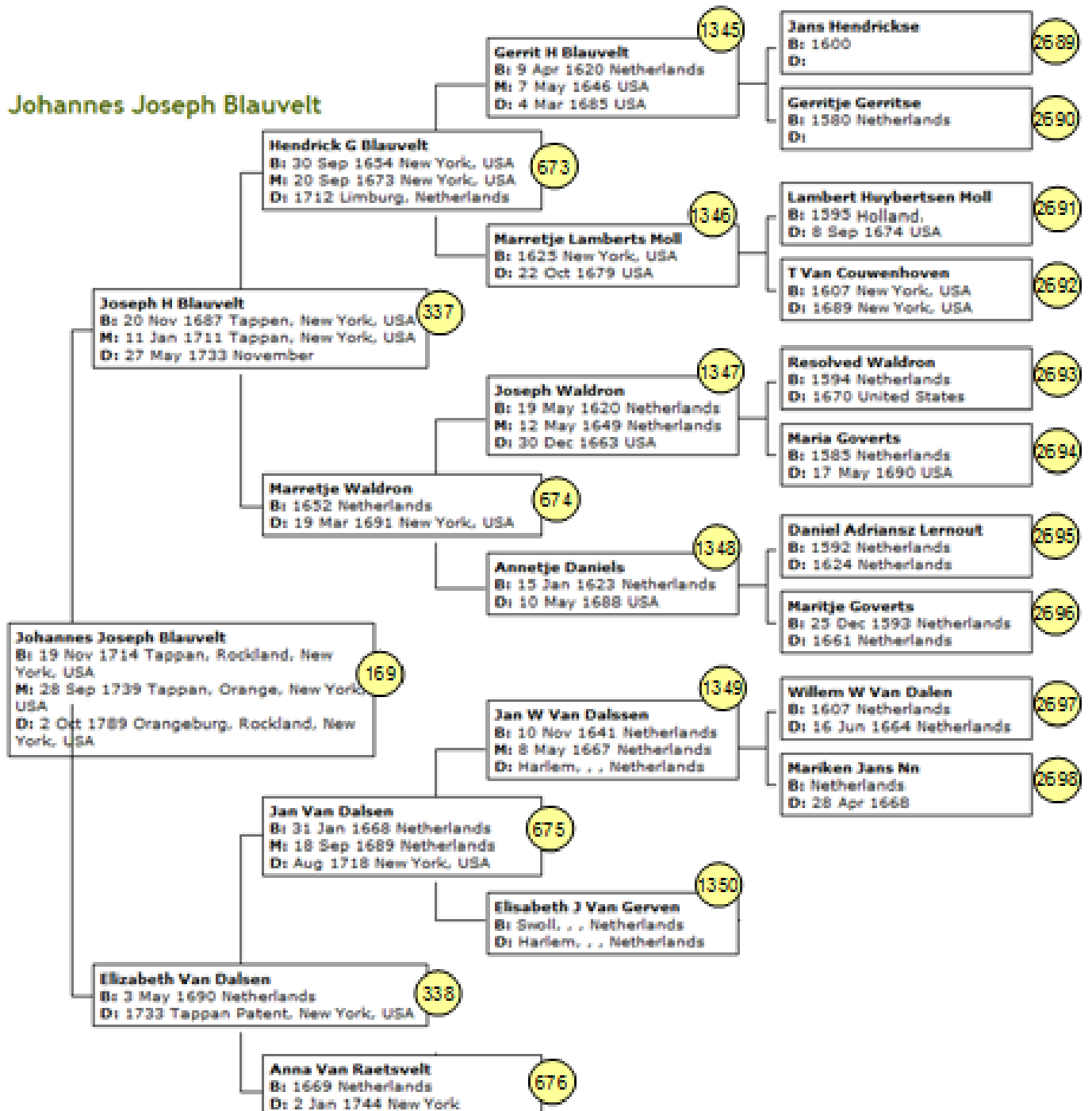

The Snyder Family History, all direct line relatives back to the Colonies

H170

H-Gen I-Gen J-Gen K-Gen L-Gen

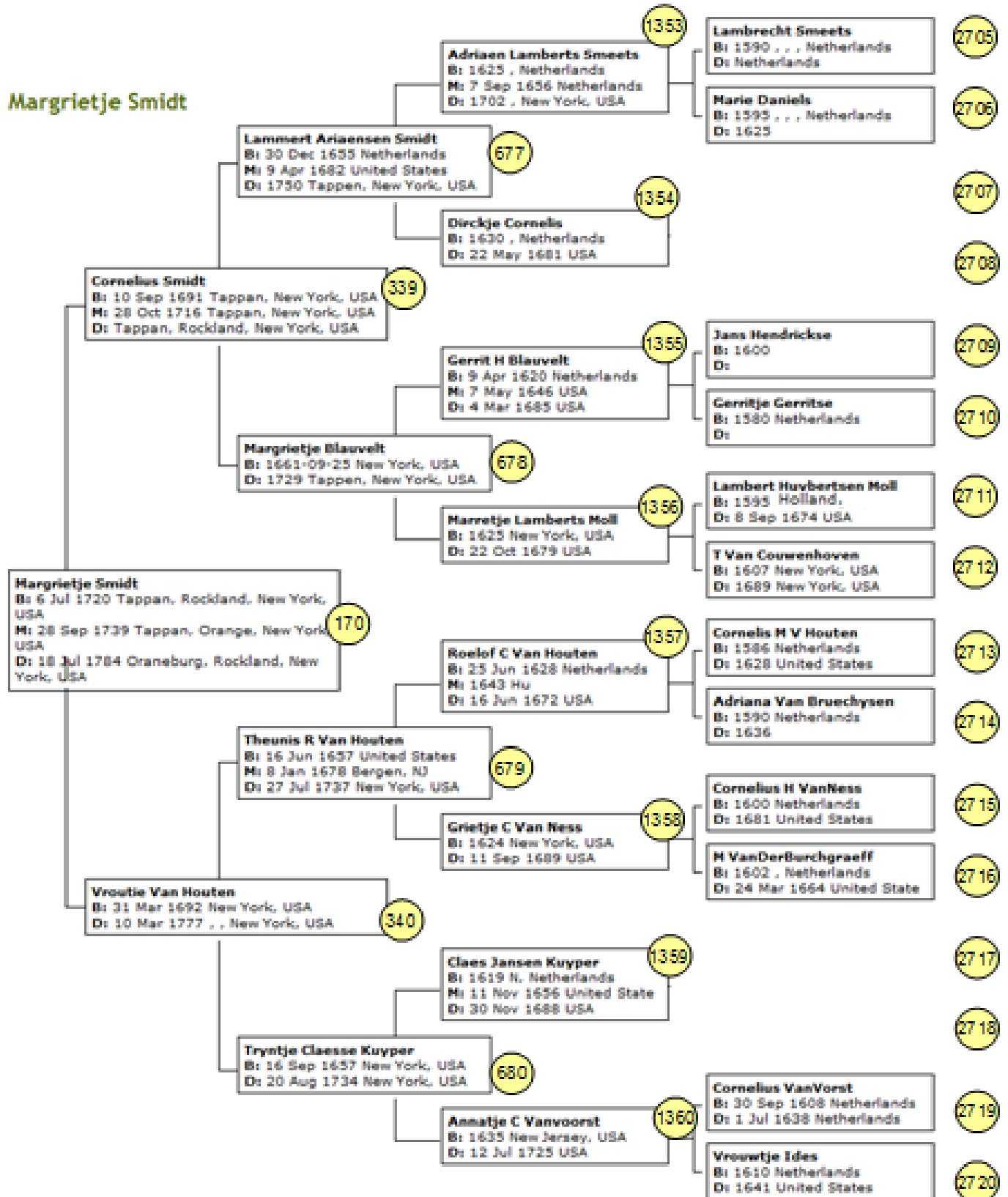

The Snyder Family History, all direct line relatives back to the Colonies

H171

H-Gen I-Gen J-Gen K-Gen L-Gen

William Nagel

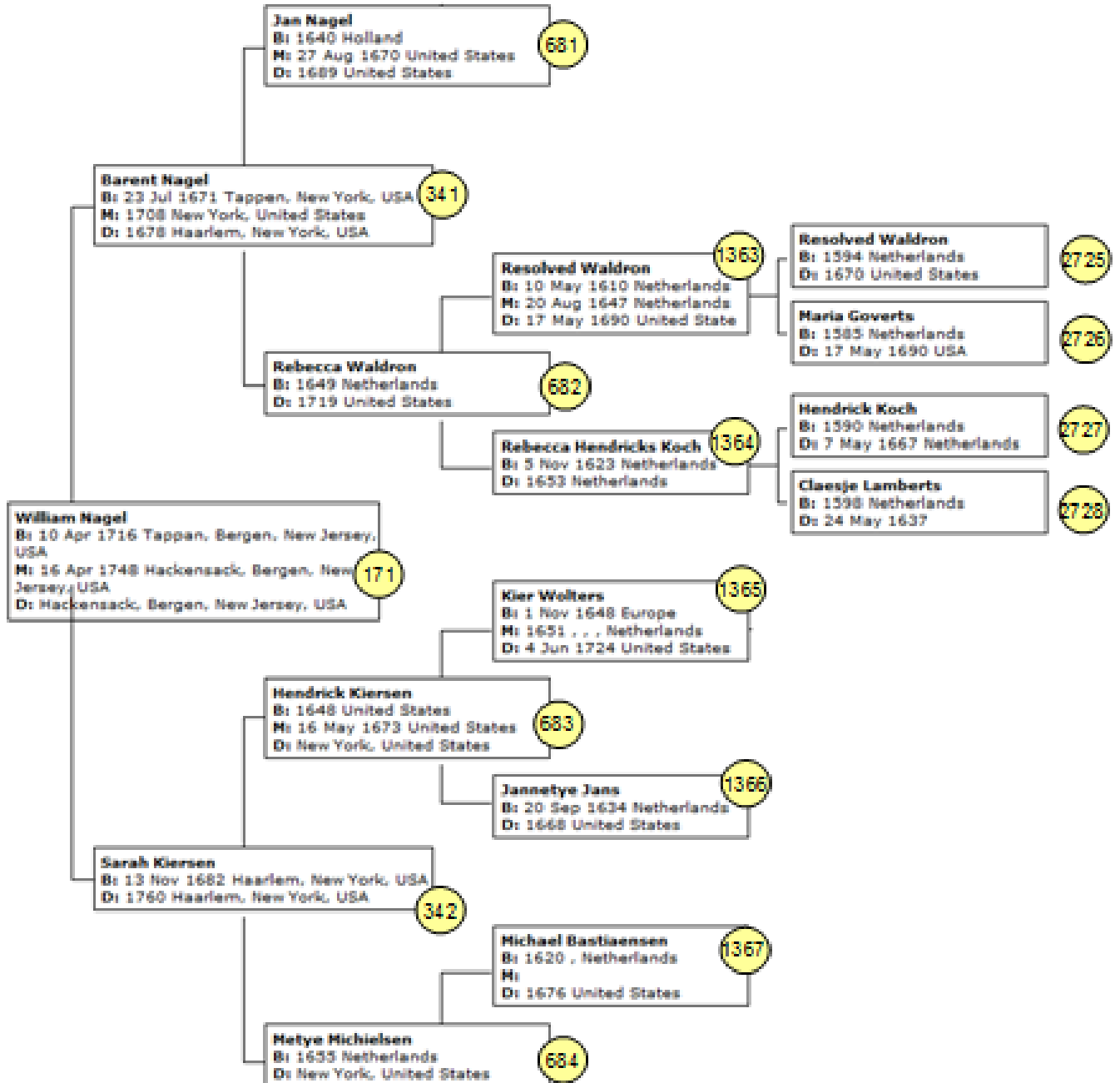

The Snyder Family History, all direct line relatives back to the Colonies

H172

H-Gen I-Gen J-Gen K-Gen L-Gen

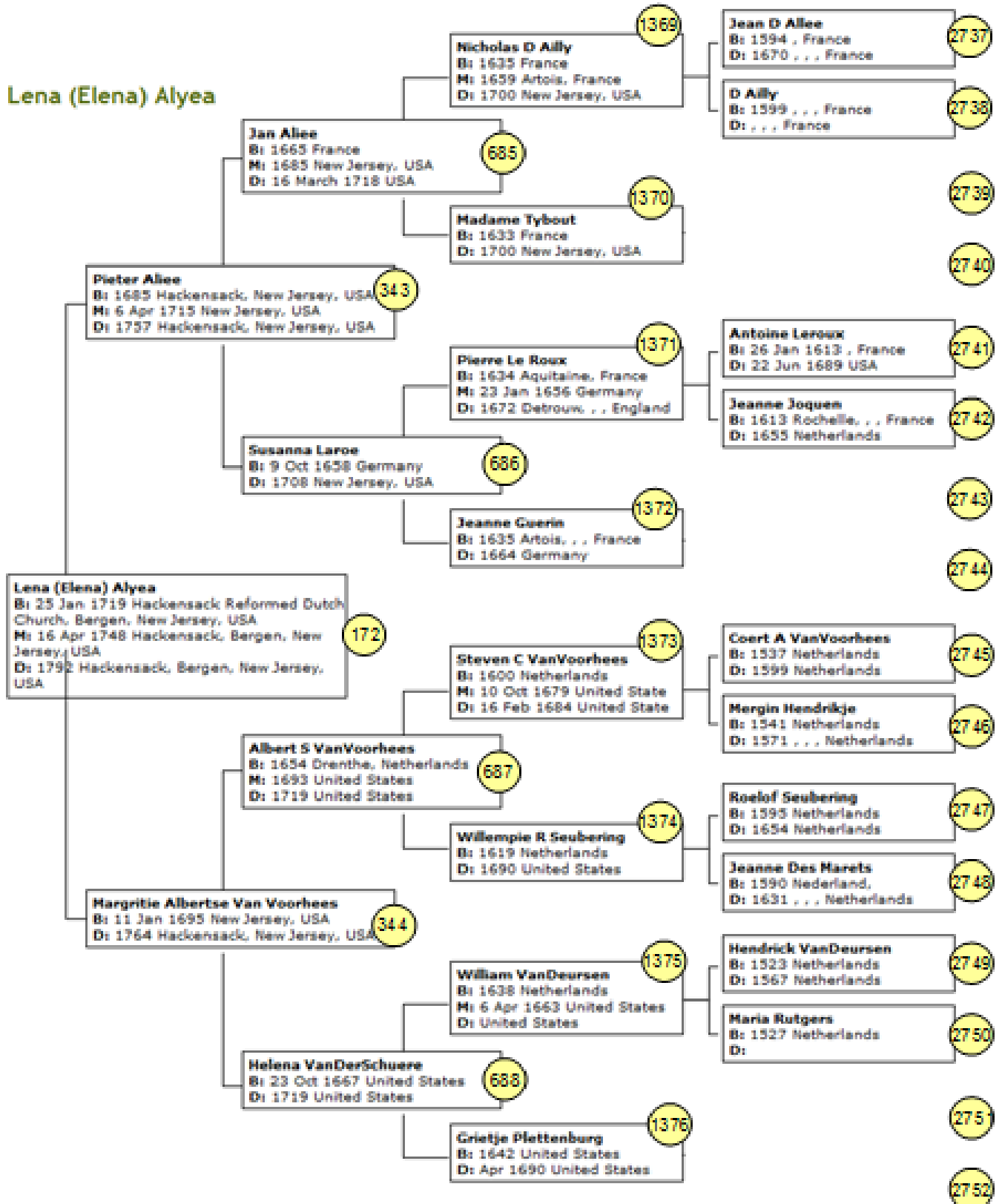

The Snyder Family History, all direct line relatives back to the Colonies

H173

H-Gen I-Gen J-Gen K-Gen L-Gen

Jacob VANDERBILT

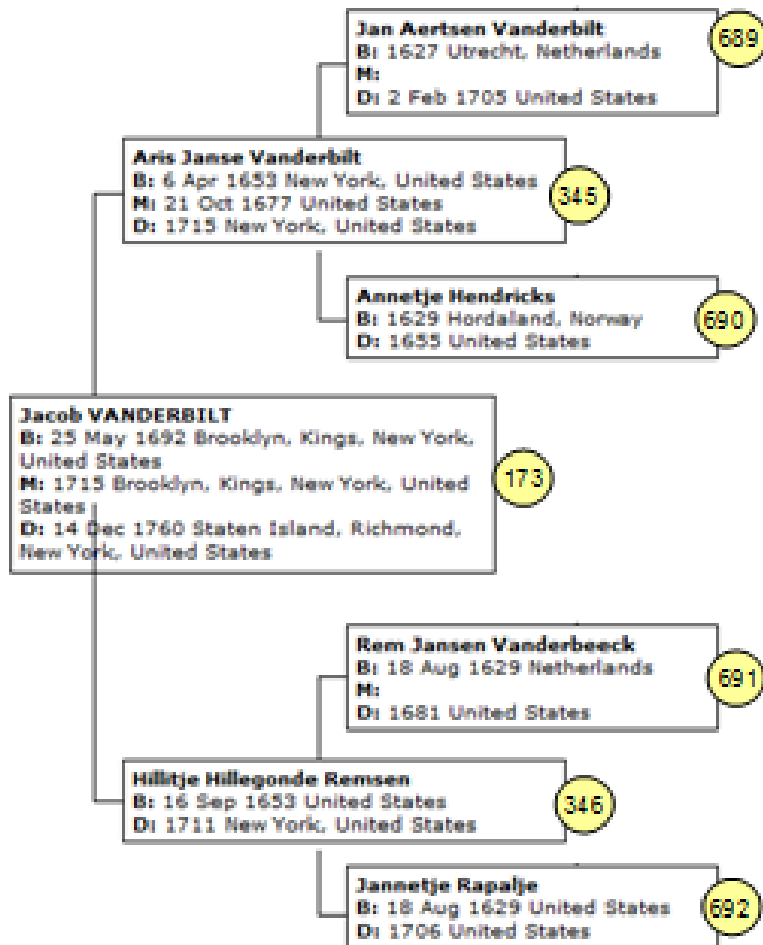

The Snyder Family History, all direct line relatives back to the Colonies

H174

H-Gen I-Gen J-Gen K-Gen L-Gen

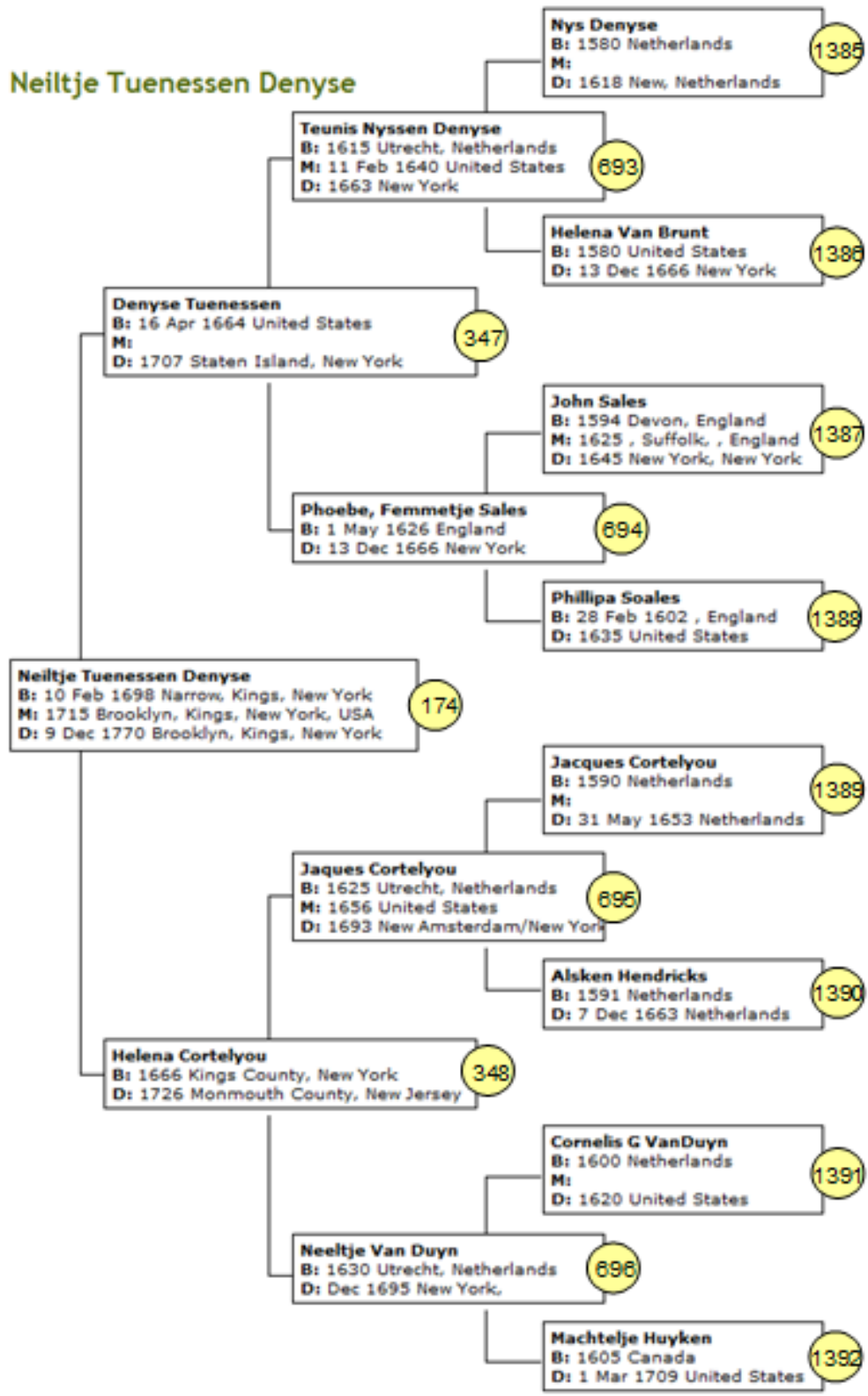

The Snyder Family History, all direct line relatives back to the Colonies

H177

H-Gen I-Gen J-Gen K-Gen L-Gen

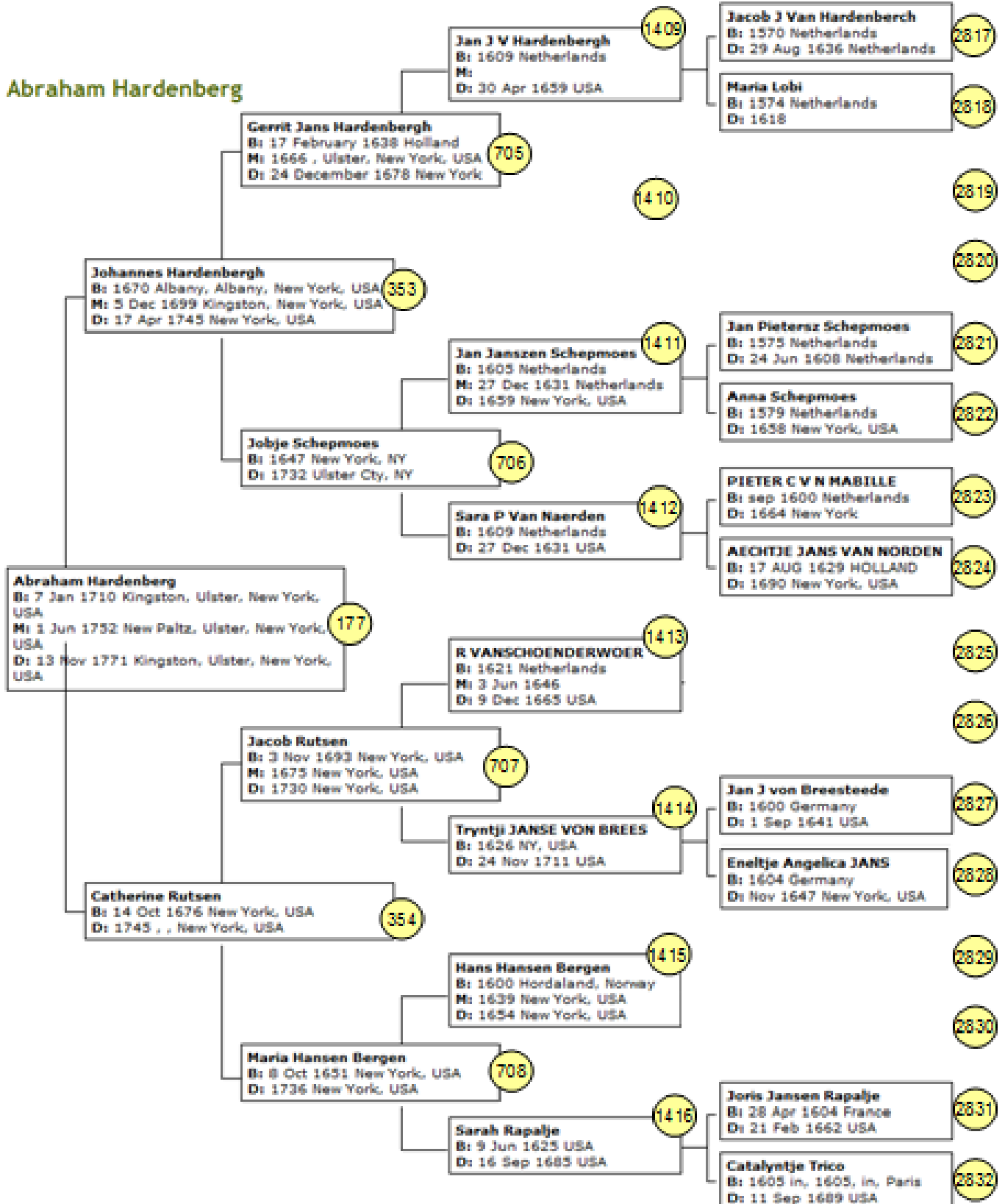

The Snyder Family History, all direct line relatives back to the Colonies

H178

H-Gen I-Gen J-Gen K-Gen L-Gen

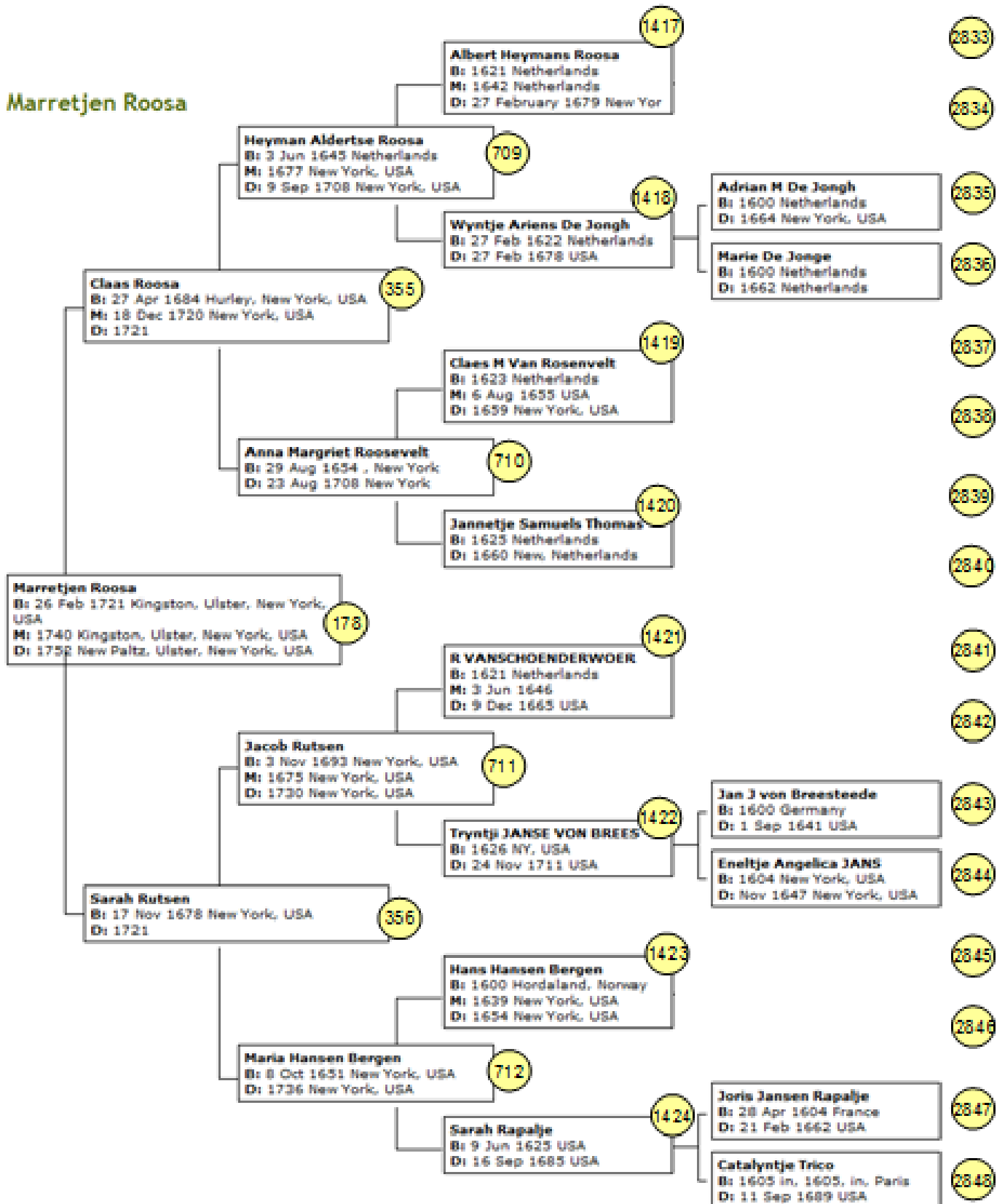

The Snyder Family History, all direct line relatives back to the Colonies

H179

H-Gen I-Gen J-Gen K-Gen L-Gen

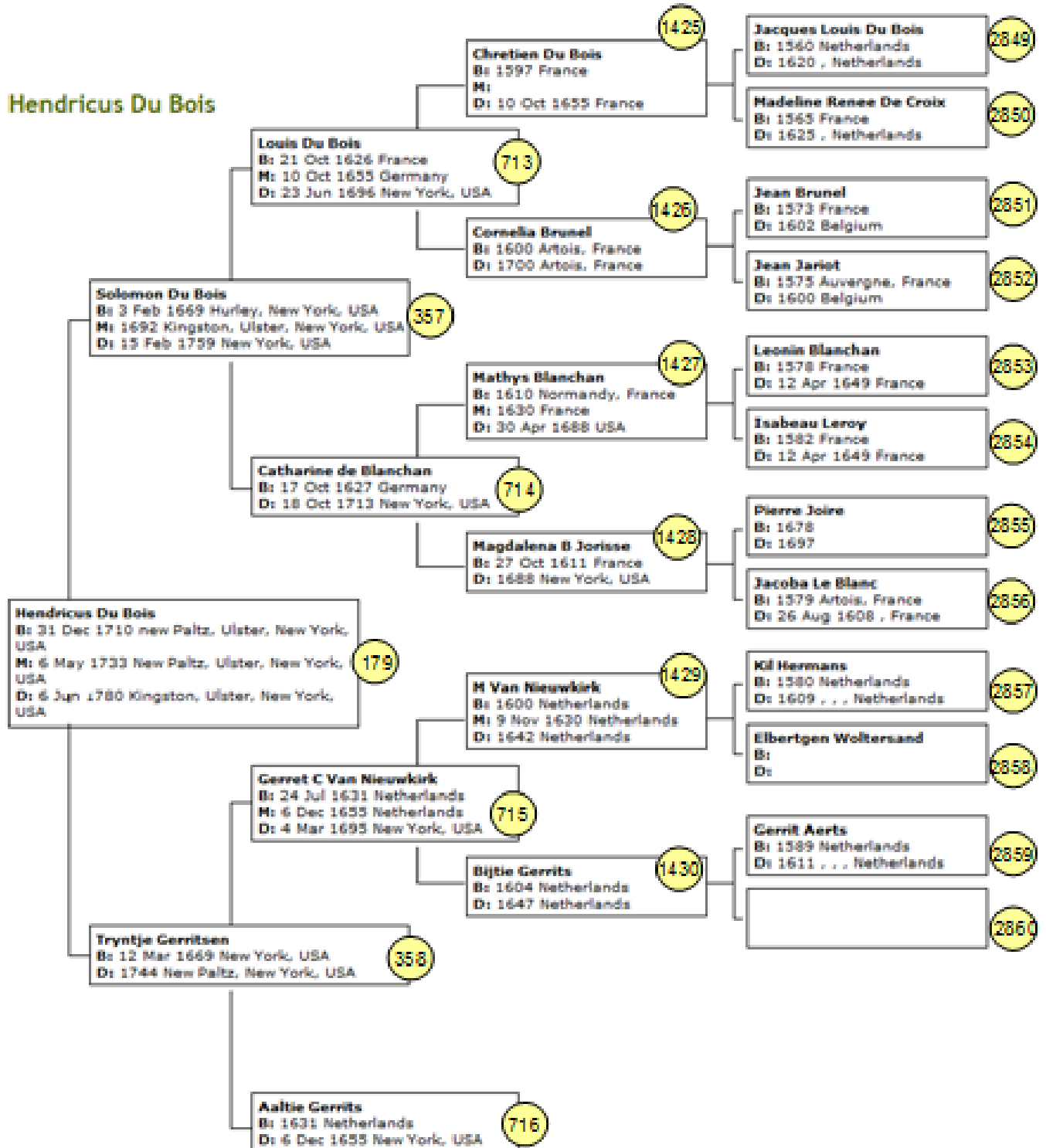

The Snyder Family History, all direct line relatives back to the Colonies

H180

H-Gen I-Gen J-Gen K-Gen L-Gen

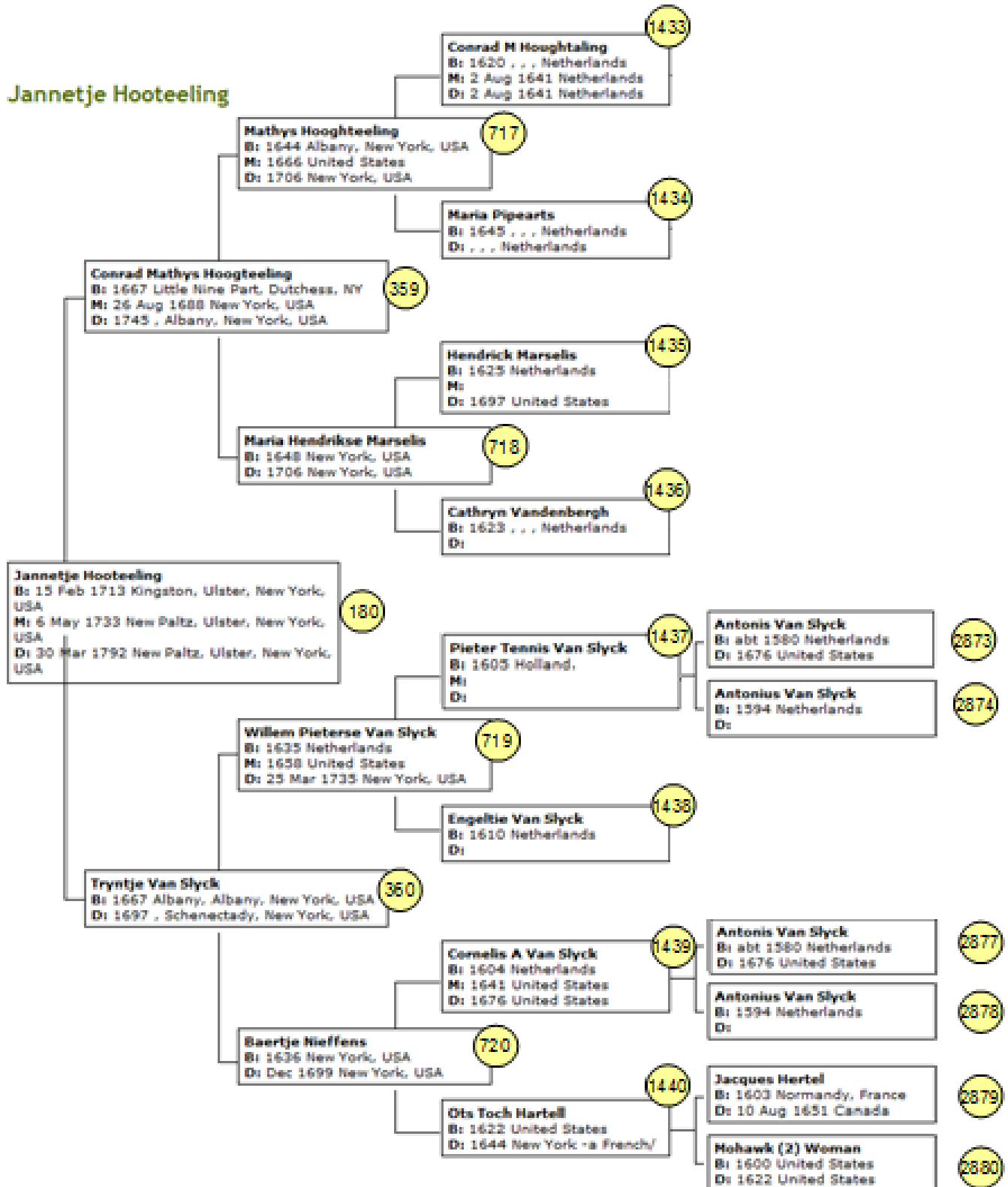

The Snyder Family History, all direct line relatives back to the Colonies

H181

H-Gen I-Gen J-Gen K-Gen L-Gen

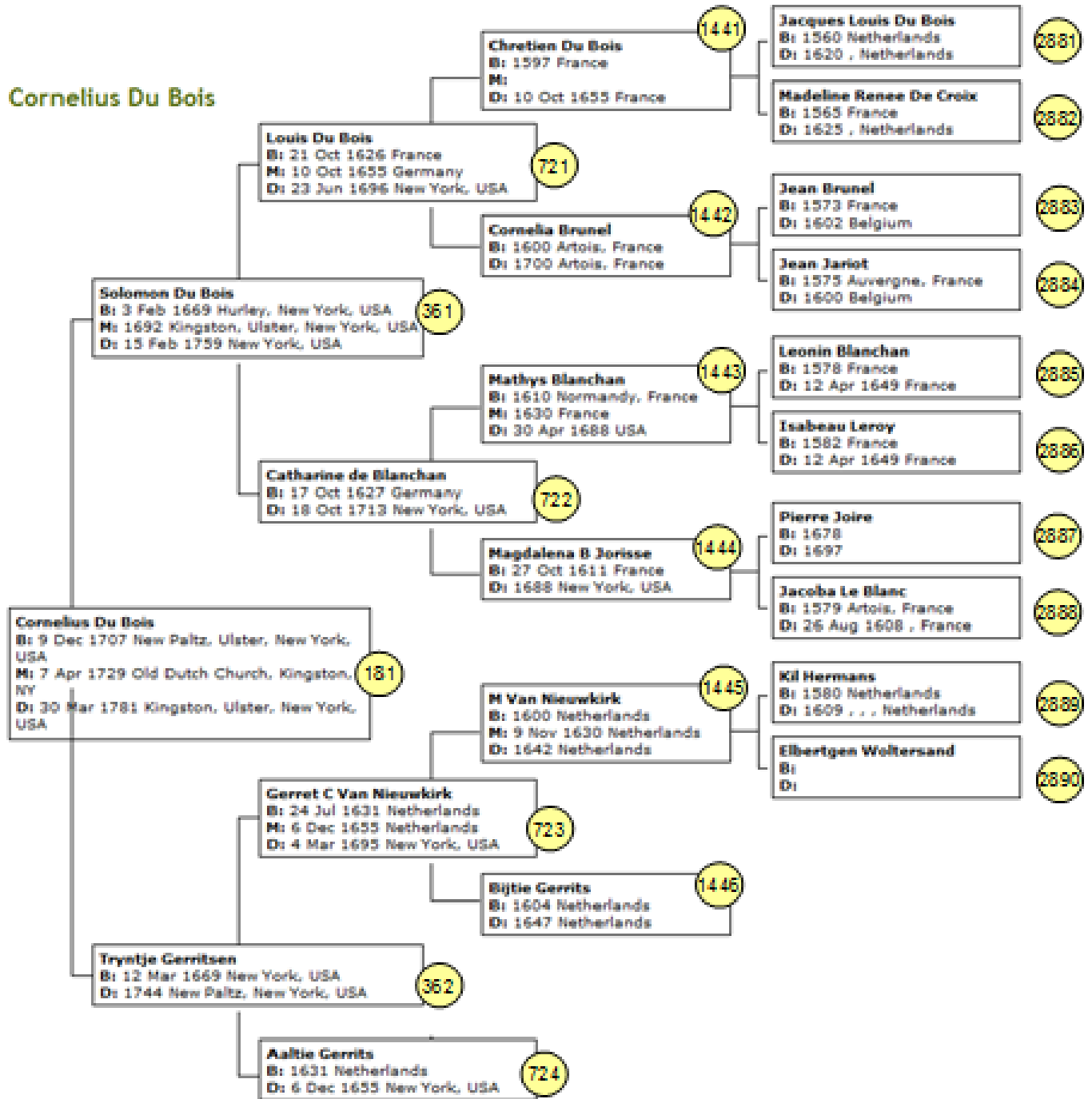

The Snyder Family History, all direct line relatives back to the Colonies

H182

H-Gen I-Gen J-Gen K-Gen L-Gen

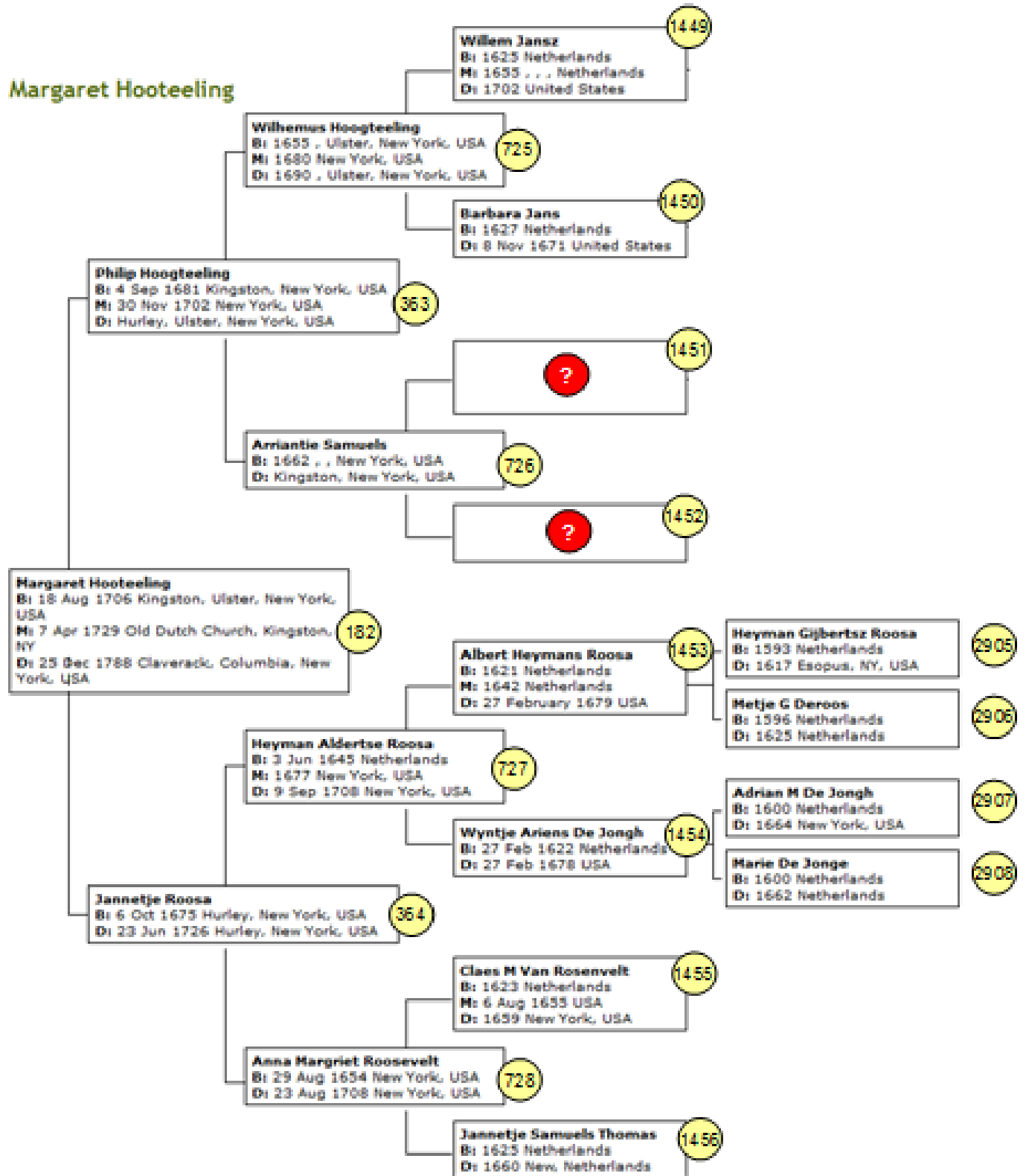

The Snyder Family History, all direct line relatives back to the Colonies

H183

H-Gen I-Gen J-Gen K-Gen L-Gen

Jacobus Bruyn

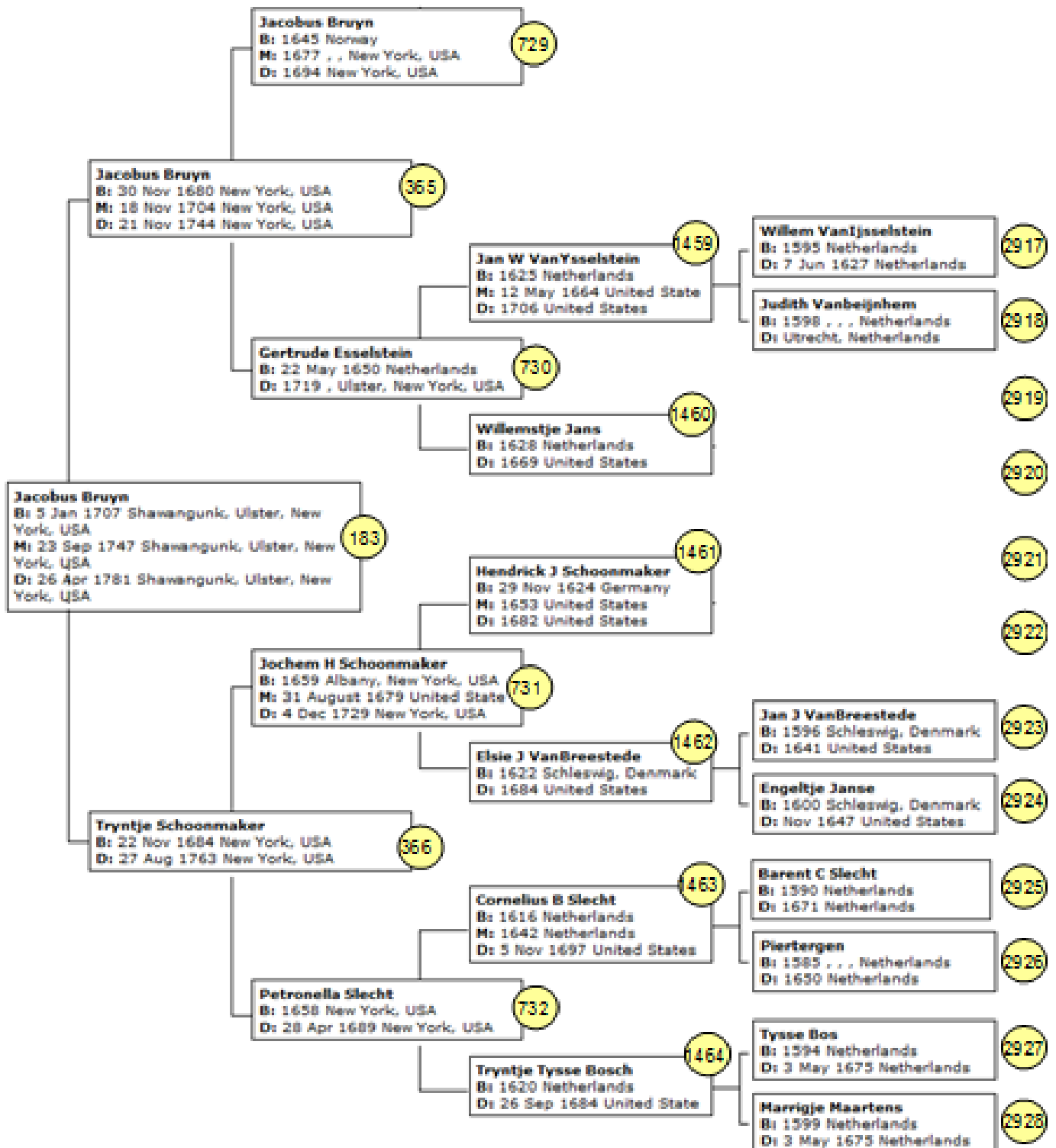

The Snyder Family History, all direct line relatives back to the Colonies

H184

H-Gen I-Gen J-Gen K-Gen L-Gen

Jeannie Graham

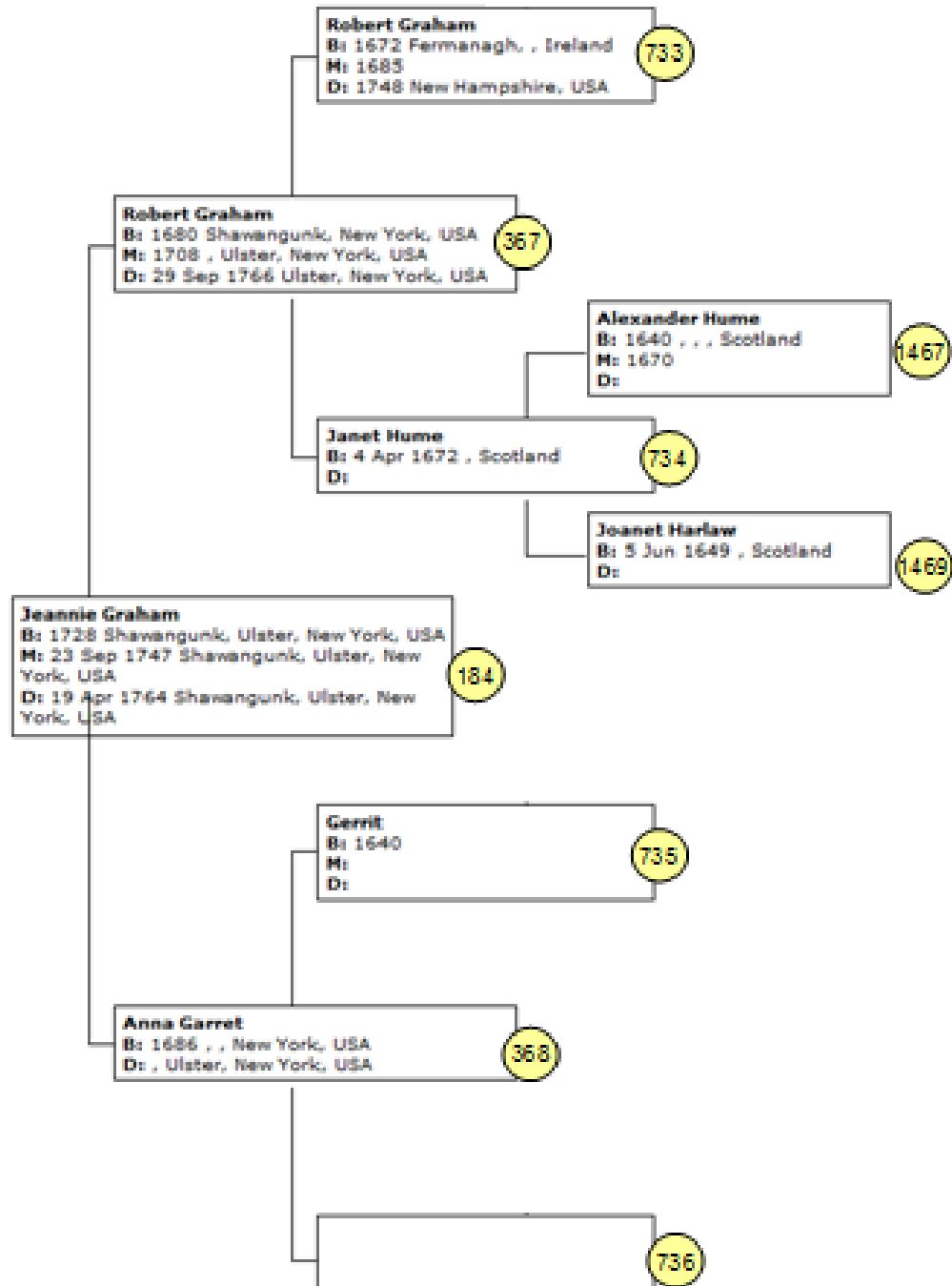

The Snyder Family History, all direct line relatives back to the Colonies

H185

H-Gen I-Gen J-Gen K-Gen L-Gen

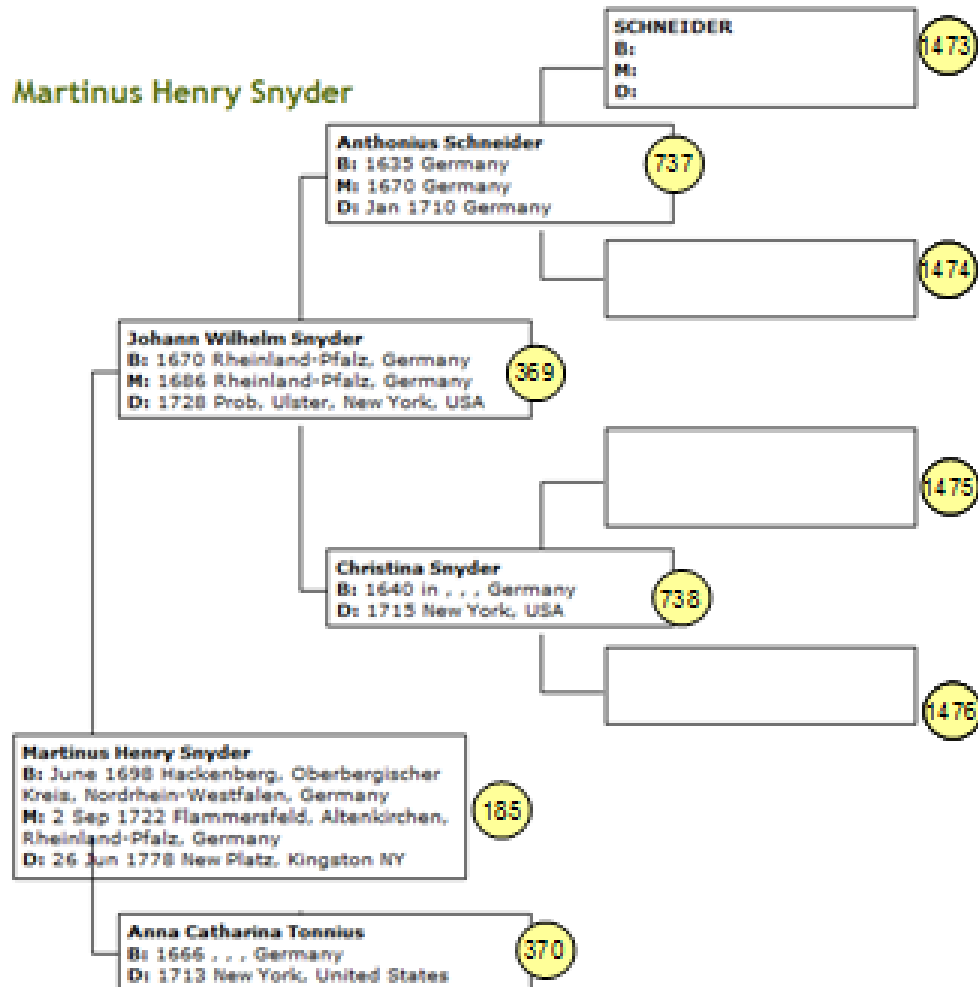

H186

H-Gen I-Gen J-Gen K-Gen L-Gen

Annah Dean nute Bacher

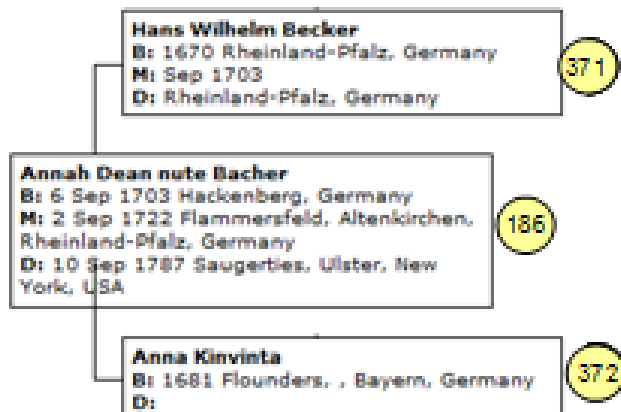

The Snyder Family History, all direct line relatives back to the Colonies

H187

H-Gen I-Gen J-Gen K-Gen L-Gen

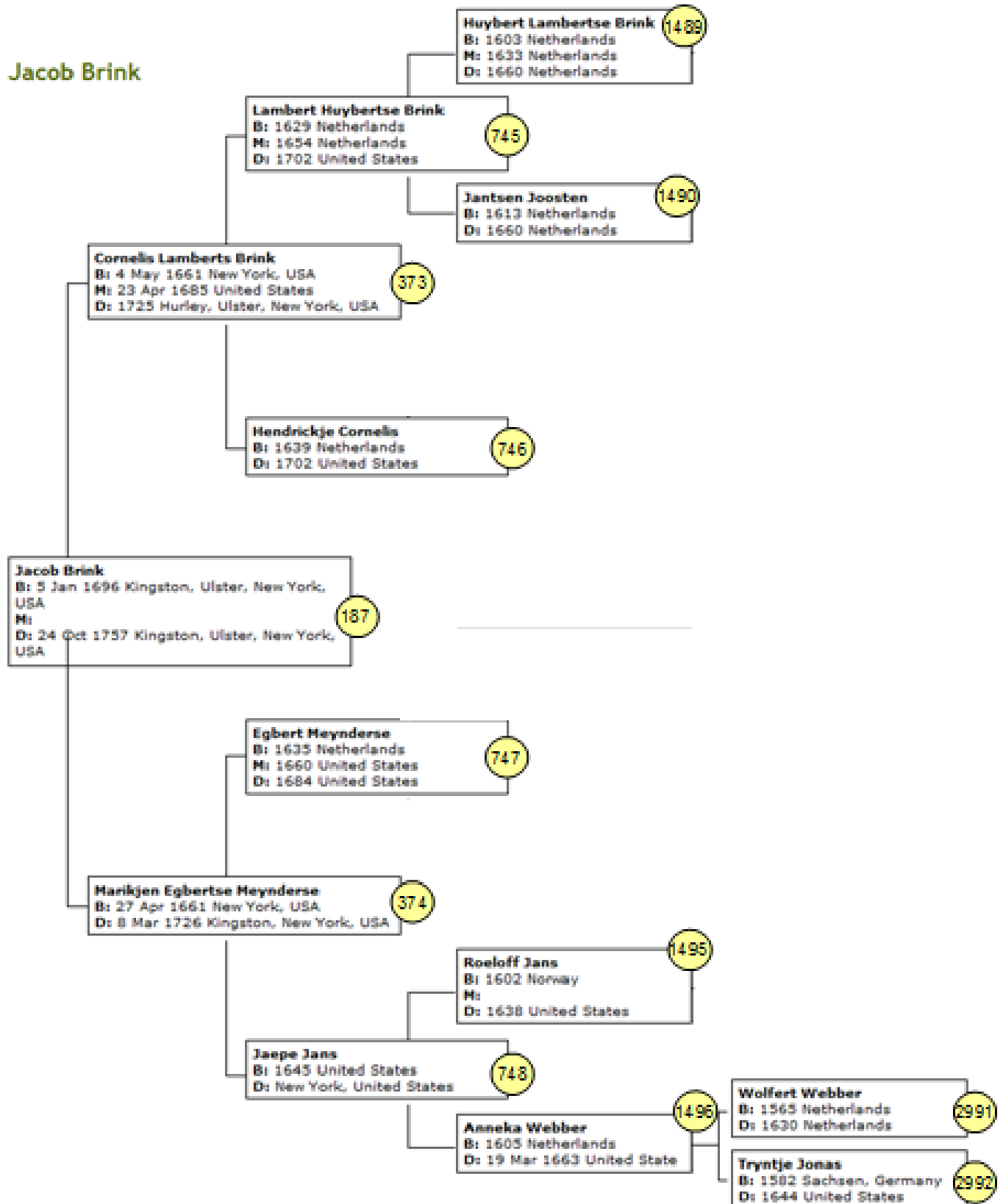

The Snyder Family History, all direct line relatives back to the Colonies

H188

H-Gen I-Gen J-Gen K-Gen L-Gen

Maritje Legg Elich

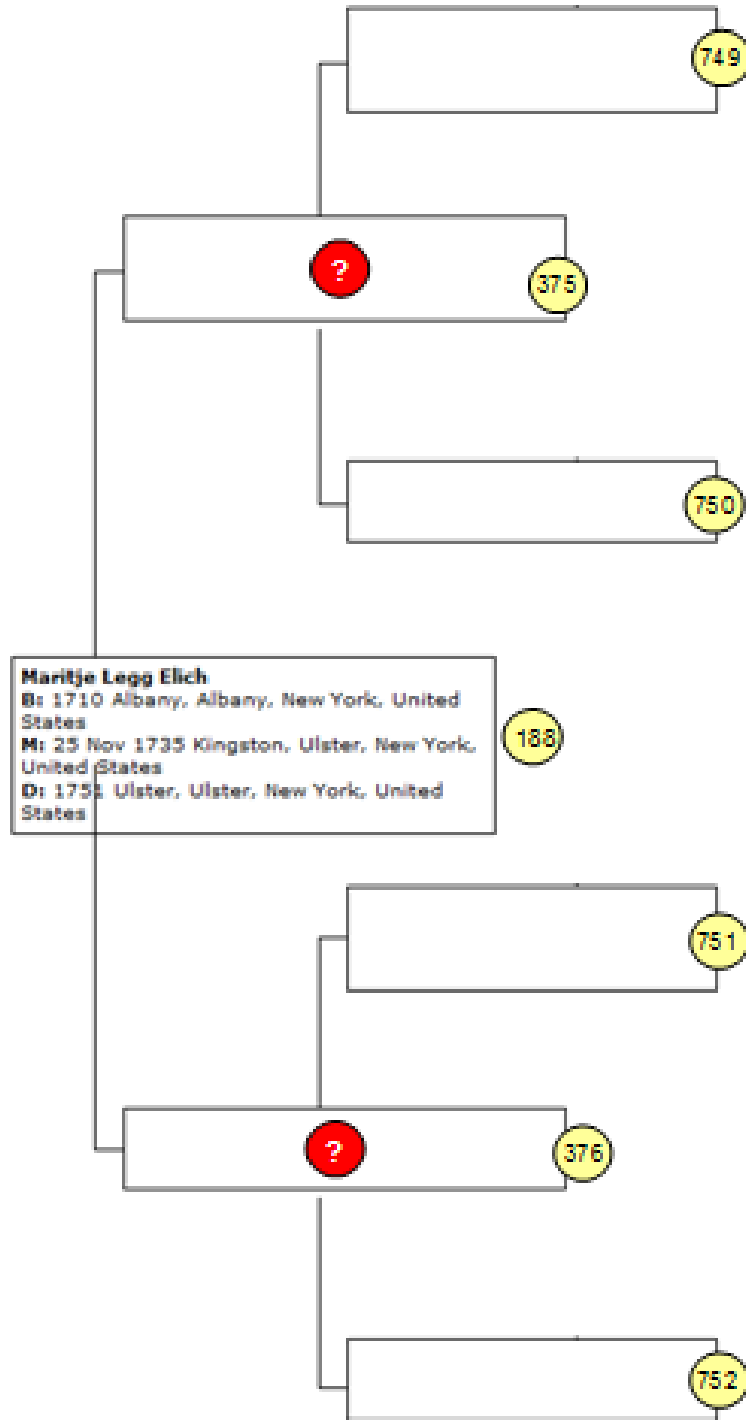

The Snyder Family History, all direct line relatives back to the Colonies

H191

H-Gen I-Gen J-Gen K-Gen L-Gen

Johannes Carn

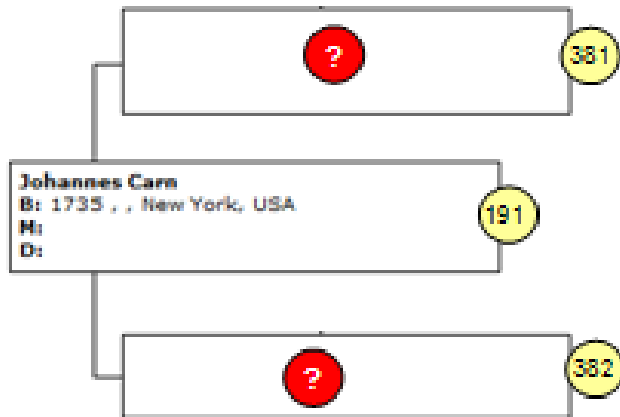

H192

H-Gen I-Gen J-Gen K-Gen L-Gen

Eva Nagel

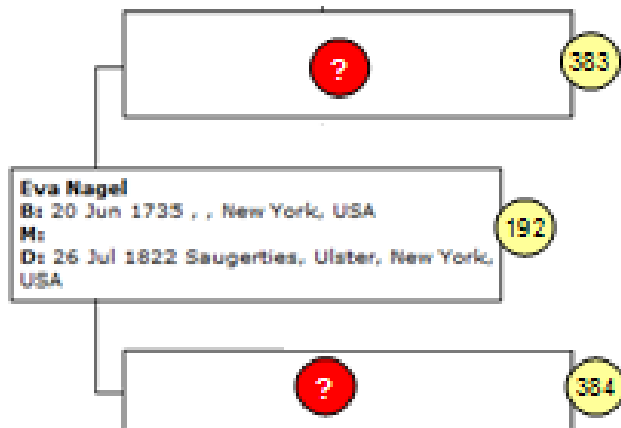

The Snyder Family History, all direct line relatives back to the Colonies

**The Petersen / Snyder Family in America
Volume 1**

Compiled by
Mark L. Petersen
2008/2009

Section IV – INDEX Snyder/Petersen Lineage

The Snyder Family History, all direct line relatives back to the Colonies

| Last name | First/Last Name - GEN | Page | Last name | First/Last Name - GEN | Page | Last name | First/Last Name - GEN | Page |
|-------------------------------|---|------|-----------------------|--|------|----------------------|--|------|
| Aliee I343 | Pieter Aliee I343 | 142 | Bogaert /Bogart K1343 | Jan Louwe Bogaert /Bogart K1343 | 354 | Cornelis K1338 | Dirckje Cornelis K1338 | 344 |
| Aliee J685 | Jan Aliee J685 | 244 | Bogart J672 | Margrietje Jans Bogart J672 | 230 | Cornelis K1354 | Dirckje Cornelis K1354 | 359 |
| Alyea H172 | Lena (Elena) Alyea H172 | 95 | Bosch K1264 | Tryntje Tysse Bosch K1264 | 299 | Cornelisse I266 | Hendrickje Cornelisse I266 | 104 |
| Arents J532 | Lysbeth Arents J532 | 166 | Bosch K1464 | Tryntje Tysse Bosch K1464 | 403 | Cortelyou I348 | Helena Cortelyou I348 | 145 |
| Arents K1160 | Claertje Arents K1160 | 274 | Bosch L2480 | Trintje Tysse Bosch L2480 | 408 | Cortelyou J695 | Jacques Cortelyou J695 | 252 |
| Bacher G66, G70, H186, H190 * | Annah Dean nute Bacher G66, G70, H186, H190 * | 67 | Brink F34 | Annatjen Brink F34 | 53 | Cosyn K1342 | Grietje Cosyn K1342 | 353 |
| Bacher H186 | Annah Dean nute Bacher H186 | 99 | Brink G67 | Jacob Brink G67 | 67 | Cuyl J531 | Cornelis Barentsen Cuyl J531 | 166 |
| Bacher H190 | Annah Dean nute Bacher H190 | 101 | Brink G94 | Annatjen Brink G94 | 82 | D Ailly K1369 | Nicholas D Ailly K1369 | 367 |
| Bastiaensen K1367 | Michiel Bastiaensen K1367 | 366 | Brink H187 | Jacob Brink H187 | 100 | Daniels K1348 | Annetje Daniels K1348 | 358 |
| Bergen J708 | Maria Hansen Bergen J708 | 258 | Brink I265 | Lambert Huybertse Brink I265 | 102 | Davis I304 | Deborah Davis I304 | 121 |
| Bergen J712 | Maria Hansen Bergen J712 | 259 | Brink I373 | Cornelis Lamberts Brink I373 | 163 | Davis J607 | Christopher "Kit" Davis J607 | 184 |
| Bergen K1415 | Hans Hansen Bergen K1415 | 389 | Brink J529 | Huybert Lambertse (Brink) J529 | 165 | De Jongh K1278 | Wyntje Ariens De Jongh K1278 | 308 |
| Bergen K1423 | Hans Hansen Bergen K1423 | 394 | Bruyn G92 | Geertie Bruyn G92 | 81 | De Jongh K1418 | Wyntje Ariens De Jongh K1418 | 393 |
| Bevier I314 | Hester Bevier I314 | 126 | Bruyn H158 | Maria (Hasbrouck) Bruyn H158 | 89 | De Jongh K1454 | Wyntje Ariens De Jongh K1454 | 400 |
| Bevier J627 | Louis Bevier J627 | 198 | Bruyn H183 | Jacobus Bruyn H183 | 99 | De Jongh L2555 | Adrian Meertensen De Jongh L2555 | 410 |
| Blanchan I292 | Elizabeth Blanchan I292 | 112 | Bruyn I315 | Jacobus (2) Bruyn I315 | 126 | De Jongh L2836 L2907 | Adrian Meertensen De Jongh L2836 L2907 | 433 |
| Blanchan J583 | Mathys Blanchan J583 | 175 | Bruyn I365 | Jacobus (2) Bruyn I365 | 161 | DeGraw K1314 | Marretje Leenderts DeGraw K1314 | 333 |
| Blanchan J624 | Magdalena Blanchan J624 | 192 | Bruyn J629 | Jacobus Bruyn J629 | 202 | Dennis H164 | Elizabeth Dennis H164 | 91 |
| Blanchan J634 | Catharine Blanchan J634 | 211 | Bruyn J729 | Jacobus Bruyn J729 | 266 | Denyse H174 | Neeltje Tuenessen Denyse H174 | 96 |
| Blanchan J714 | Catharine Blanchan J714 | 260 | Burhans H156 | Elizabeth Burhans H156 | 88 | Denyse J693 | Teunis Nyssen Denyse J693 | 249 |
| Blanchan J722 | Catharine Blanchan J722 | 264 | Burhans I311 | Barent Burhans I311 | 122 | Des Chalet J600 | Claude Des Chalet J600 | 180 |
| Blanchan K1247 | Mathys Blanchan K1247 | 292 | Burhans J621 | Jan Jacob Burhans J621 | 189 | Deyo G76 | Sara Deyo G76 | 69 |
| Blanchan K1267 | Matthys Blanchan K1267 | 299 | Burhans K1241 | Jacob Burhans K1241 | 282 | Deyo H151 | Hendricus Deyo H151 | 87 |
| Blanchan K1427 | Matthys Blanchan K1427 | 394 | Carey K1284 | Sarah Carey K1284 | 318 | Deyo I301 | Pieter Deyo I301 | 118 |
| Blanchan K1443 | Matthys Blanchan K1443 | 399 | Carey L2567 | John Carey L2567 | 411 | Deyo J601 | Christian Deyo J601 | 180 |
| Blauvelt E22 | Maria Blauvelt E22 | 47 | Cam F36 – G96 | Susannah Margaritta (Susan Margaret) Cam F36 | 54 | Deyo J626 | Anna Deyo J626 | 196 |
| Blauvelt F43 | Johannes Blauvelt F43 | 64 | Cam G96 | Susannah Margaritta Cam G96 | 83 | Deyo K1251 | Christian Deyo K1251 | 293 |
| Blauvelt G85 | Cornelius Blauvelt G85 | 79 | Cam H191 | Johannes Cam H191 | 101 | Du Bois I317 | Solomon Du Bois I317 | 129 |
| Blauvelt H169 | Johannes Joseph Blauvelt H169 | 94 | Carpenter K1286 | Juliana Carpenter K1286 | 321 | Du Bois F46 | Jane Du Bois F46 | 64 |
| Blauvelt I337 | Joseph H. Blauvelt I337 | 139 | Carpenter K1288 | Priscilla Carpenter K1288 | 323 | Du Bois G80 | Sara Du Bois G80 | 70 |
| Blauvelt J670 | Margrietje Gerrits Blauvelt J670 | 229 | Chesne K1212 | Susanna du Chesne K1212 | 278 | Du Bois G90 | Rachel Du Bois G90 | 80 |
| Blauvelt J673 | Hendrick Gerritsen Blauvelt J673 | 230 | Cole F42 | Catharine Cole F42 | 61 | Du Bois G91 | Cornelius JR Du Bois G91 | 81 |
| Blauvelt J678 | Margrietje Gerrits Blauvelt J678 | 239 | Cole G83 | Isaac Abrahamsen Cole G83 | 75 | Du Bois H159 | Cornelius Du Bois H159 | 90 |
| Blauvelt K1339 | Gerrit Hendricksen Blauvelt K1339 | 344 | Coleson K1282 | Joan Coleson K1282 | 316 | Du Bois H179 | Hendricus Du Bois H179 | 97 |
| Blauvelt K1345 | Gerrit Hendricksen Blauvelt K1345 | 356 | Cooper J644 | Ann Cooper J644 | 220 | Du Bois H181 | Cornelius Du Bois H181 | 98 |
| Blauvelt K1355 | Gerrit Hendricksen Blauvelt K1355 | 359 | Cooper K1287 | John Cooper K1287 | 322 | Du Bois I357 | Solomon Du Bois I357 | 148 |

The Snyder Family History, all direct line relatives back to the Colonies

| Last name | First/Last Name - GEN | Page | Last name | First/Last Name - GEN | Page | Last name | First/Last Name - GEN | Page |
|--------------------------------|---|------|--------------------------|--|------|-------------------------|---|------|
| Aliee I343 | Pieter Aliee I343 | 142 | Bogaert /Bogart K1343 | Jan Louwe Bogaert /Bogart K1343 | 354 | Cornelis K1338 | Dirckje Cornelis K1338 | 344 |
| Aliee J685 | Jan Aliee J685 | 244 | Bogart J672 | Margrietje Jans Bogart J672 | 230 | Cornelis K1354 | Dirckje Cornelis K1354 | 359 |
| Alyea H172 | Lena (Elena) Alyea H172 | 95 | Bosch K1264 | Tryntje Tysse Bosch K1264 | 299 | Cornelisse I266 | Hendrickje Cornelisse I266 | 104 |
| Arents J532 | Lysbeth Arents J532 | 166 | Bosch K1464 | Tryntje Tysse Bosch K1464 | 403 | Cortelyou I348 | Helena Cortelyou I348 | 145 |
| Arents K1160 | Claertje Arents K1160 | 274 | Bosch L2480 | Trintje Tysse Bosch L2480 | 408 | Cortelyou J695 | Jacques Cortelyou J695 | 252 |
| Bacher G66, G70, H186, H190 | Annah Dean nute Bacher G66, G70, H186, | 67 | Brink F34 | Annatjen Brink F34 | 53 | Cosyn K1342 | Grietje Cosyn K1342 | 353 |
| Bacher H186 | Annah Dean nute Bacher H186 | 99 | Brink G67 | Jacob Brink G67 | 67 | Cuyl J531 | Cornelis Barentsen Cuyl J531 | 166 |
| Bacher H190 | Annah Dean nute Bacher H190 | 101 | Brink G94 | Annatjen Brink G94 | 82 | D Ailly K1369 | Nicholas D Ailly K1369 | 367 |
| Bastiaensen K1367 | Michiel Bastiaensen K1367 | 366 | Brink H187 | Jacob Brink H187 | 100 | Daniels K1348 | Annetje Daniels K1348 | 358 |
| Bergen J708 | Maria Hansen Bergen J708 | 258 | Brink I265 | Lambert Huybertse Brink I265 | 102 | Davis I304 | Deborah Davis I304 | 121 |
| Bergen J712 | Maria Hansen Bergen J712 | 259 | Brink I373 | Cornelis Lamberts Brink I373 | 163 | Davis J607 | Christopher "Kit" Davis J607 | 184 |
| Bergen K1415 | Hans Hansen Bergen K1415 | 389 | Brink J529 | Huybert Lambertse (Brink) J529 | 165 | De Jongh K1278 | Wyntje Ariens De Jongh K1278 | 308 |
| Bergen K1423 | Hans Hansen Bergen K1423 | 394 | Bruyn G92 | Geertie Bruyn G92 | 81 | De Jongh K1418 | Wyntje Ariens De Jongh K1418 | 393 |
| Bevier I314 | Hester Bevier I314 | 126 | Bruyn H158 | Maria (Hasbrouck) Bruyn H158 | 89 | De Jongh K1454 | Wyntje Ariens De Jongh K1454 | 400 |
| Bevier J627 | Louis Bevier J627 | 198 | Bruyn H183 | Jacobus Bruyn H183 | 99 | De Jongh L2555 | Adrian Meertensen De Jongh L2555 | 410 |
| Blanchan I292 | Elizabeth Blanchan I292 | 112 | Bruyn I315 | Jacobus (2) Bruyn I315 | 126 | De Jongh L2836 L2907 | Adrian Meertensen De Jongh L2836 L2907 | 433 |
| Blanchan J583 | Mathys Blanchan J583 | 175 | Bruyn I365 | Jacobus (2) Bruyn I365 | 161 | DeGraw K1314 | Marretje Leenderts DeGraw K1314 | 333 |
| Blanchan J624 | Magdalena Blanchan J624 | 192 | Bruyn J629 | Jacobus Bruyn J629 | 202 | Dennis H164 | Elizabeth Dennis H164 | 91 |
| Blanchan J634 | Catharine Blanchan J634 | 211 | Bruyn J729 | Jacobus Bruyn J729 | 266 | Denyse H174 | Neeltje Tuenessen Denyse H174 | 96 |
| Blanchan J714 | Catharine Blanchan J714 | 260 | Burhans H156 | Elizabeth Burhans H156 | 88 | Denyse J693 | Teunis Nyssen Denyse J693 | 249 |
| Blanchan J722 | Catharine Blanchan J722 | 264 | Burhans I311 | Barent Burhans I311 | 122 | Des Chalet J600 | Claude Des Chalet J600 | 180 |
| Blanchan K1247 | Mathys Blanchan K1247 | 292 | Burhans J621 | Jan Jacob Burhans J621 | 189 | Deyo G76 | Sara Deyo G76 | 69 |
| Blanchan K1267 | Mathys Blanchan K1267 | 299 | Burhans K1241 | Jacob Burhans K1241 | 282 | Deyo H151 | Hendricus Deyo H151 | 87 |
| Blanchan K1427 | Mathys Blanchan K1427 | 394 | Carey K1284 | Sarah Carey K1284 | 318 | Deyo I301 | Pieter Deyo I301 | 118 |
| Blanchan K1443 | Mathys Blanchan K1443 | 399 | Carey L2567 | John Carey L2567 | 411 | Deyo J601 | Christian Deyo J601 | 180 |
| Blauvelt E22 | Maria Blauvelt E22 | 47 | Carn F36 – G96 | Susannah Margaritta (Susan Margaret) Carn | 54 | Deyo J626 | Anna Deyo J626 | 196 |
| Blauvelt F43 | Johannes Blauvelt F43 | 64 | Carn G96 | Susannah Margaritta Carn G96 | 83 | Deyo K1251 | Christian Deyo K1251 | 293 |
| Blauvelt G85 | Cornelius Blauvelt G85 | 79 | Carn H191 | Johannes Carn H191 | 101 | Du Bois I317 | Solomon Du Bois I317 | 129 |
| Blauvelt H169 | Johannes Joseph Blauvelt H169 | 94 | Carpenter K1286 | Juliana Carpenter K1286 | 321 | Du Bois F46 | Jane Du Bois F46 | 64 |
| Blauvelt I337 | Joseph H. Blauvelt I337 | 139 | Carpenter K1288 | Priscilla Carpenter K1288 | 323 | Du Bois G80 | Sara Du Bois G80 | 70 |
| Blauvelt J670 | Margrietje Gerrits Blauvelt J670 | 229 | Chesne K1212 | Susanna du Chesne K1212 | 278 | Du Bois G90 | Rachel Du Bois G90 | 80 |
| Blauvelt J673 | Hendrick Gerritsen Blauvelt J673 | 230 | Cole F42 | Catharine Cole F42 | 61 | Du Bois G91 | Cornelius JR Du Bois G91 | 81 |
| Blauvelt J678 | Margrietje Gerrits Blauvelt J678 | 239 | Cole G83 | Isaac Abrahamsen Cole G83 | 75 | Du Bois H159 | Cornelius Du Bois H159 | 90 |
| Blauvelt K1339 | Gerrit Hendricksen Blauvelt K1339 | 344 | Coleson K1282 | Joan Coleson K1282 | 316 | Du Bois H179 | Hendricus Du Bois H179 | 97 |
| Blauvelt K1345 | Gerrit Hendricksen Blauvelt K1345 | 356 | Cooper J644 | Ann Cooper J644 | 220 | Du Bois H181 | Cornelius Du Bois H181 | 98 |
| Blauvelt K1355 | Gerrit Hendricksen Blauvelt K1355 | 359 | Cooper K1287 | John Cooper K1287 | 322 | Du Bois I357 | Solomon Du Bois I357 | 148 |

The Snyder Family History, all direct line relatives back to the Colonies

| Last name | First/Last Name - GEN | Page | Last name | First/Last Name - GEN | Page | Last name | First/Last Name - GEN | Page |
|-------------------|---------------------------------|------|------------------|----------------------------------|------|-----------------------|-------------------------------------|------|
| Jans K1324 | Hillelje Jans K1324 | 342 | Louw I291 | Peter Cornelius Louw I291 | 112 | Pels J579 | Evert Pels J579 | 172 |
| Jans K1366 | Jannetye Jans K1366 | 365 | Low H146 | Marytje Low H146 | 85 | Pels J591 J595 | Evert Pels J591 J595 | 177 |
| Jans K1450 | Barbara Jans K1450 | 400 | Marselis J718 | Maria Hendrikse Marselis J718 | 262 | Pels J618 | Clara Evertsz Pels J618 | 186 |
| Jans K1460 | Willemstje Jans K1460 | 401 | Marselis K1435 | Hendrick Marselis K1435 | 395 | Pels K1235 | Evert Pels K1235 | 279 |
| Jans K1495 | Roeloff Jans K1495 | 403 | Matthysen J623 | Jan Matthysen J623 | 192 | Peters E20 | Maria Peters E20 | 46 |
| Jans K1496 | Anneka Webber Jans K1496 | 403 | Matthysen I312 | Margriet Jansen (Matthysen) I312 | 124 | Peters F39 | Dr. William Peters F39 | 55 |
| Jans L2828 | Eneltje Angelica Jans L2828 | 432 | Meertens J608 | Maria Meertens J608 | 184 | Peters G77 | Dr. Benjamin Peters G77 | 69 |
| Jans M5278 | Neeltgen Jans M5278 | 426 | Meyer H166 | Annetje Meyer H166 | 92 | Petersen A1 | Donald Lincoln Petersen A1 | 31 |
| Janse L2524 | Engeltje Janse L2524 | 409 | Meyer I331 | Ide Meyer I331 | 135 | Plettenburg K1376 | Grietje Plettenburg K1376 | 375 |
| Jenney J642 | Abigail Jenney J642 | 218 | Meyer J661 | Johannes Meyer J661 | 225 | Post H135 | Jan Post H135 | 84 |
| Jenney K1283 | Capt. John Jenney K1283 | 316 | Meyer K1321 | Jan Dirckszen Meyer K1321 | 338 | Rapalje J692 | Jannetje Rapalje J692 | 249 |
| Joosten J530 | Jantsen Joosten J530 | 166 | Meynderse H134 | Marikjen Egbertse Meynderse H134 | 84 | Rapalje K1383 | Joris Janeen Rapalje K1383 | 376 |
| Jorisse J584 | Magdalena Brissen Jorisse J584 | 176 | Meynderse I267 | Egbert Meynderse I267 | 105 | Rapalje K1416 | Sarah Rapalje K1416 | 392 |
| Jorisse K1248 | Magdalena Brissen Jorisse K1248 | 292 | Meynderse I374 | Marikjen Egbertse Meynderse I374 | 163 | Rapalje K1424 | Sarah Rapalje K1424 | 394 |
| Jorisse K1268 | Magdalena Brissen Jorisse K1268 | 299 | Michielsens J684 | Metje Michielsens J684 | 243 | Rapalje L2831 | Joris Janeen Rapalje L2831 | 433 |
| Jorisse K1428 | Magdalena Brissen Jorisse K1428 | 394 | Miriot M5758 | Jeanne Miriot M5758 | 437 | Remsen G88 | Jannetje Remsen G88 | 80 |
| Jorisse K1444 | Magdalena Brissen Jorisse K1444 | 399 | Mohawk L2880 | Mohawk (2) Woman L2880 | 436 | Remsen I346 | Hillitje Hillegonde Remsen I346 | 144 |
| Kern G71 | Johannes Kern G71 | 68 | Moll K1319 | Lambert Huybertsen Moll K1319 | 336 | Roosa H178 | Marretjen Roosa H178 | 97 |
| Kiersen I342 | Sarah Kiersen I342 | 141 | Moll K1340 | Marretje Lamberts Moll K1340 | 348 | Roosa I320 | Jannetje Roosa I320 | 130 |
| Kiersen J683 | Hendrick Kiersen J683 | 243 | Moll K1346 | Marretje Lamberts Moll K1346 | 356 | Roosa I355 | Claas Roosa I355 | 148 |
| Koch K1364 | Rebecca Hendricks Koch K1364 | 363 | Moll K1356 | Marretje Lamberts Moll K1356 | 359 | Roosa I364 | Jannetje Roosa I364 | 161 |
| Kool H165 | Abraham Jacobsen Kool H165 | 92 | Moll L2679 | Lambert Huybertsen Moll L2679 | 426 | Roosa J639 - J709 | Heyman Aldertse Roosa J639 - J709 | 215 |
| Kool I329 | Jacob Jacobsen Kool I329 | 133 | Morton I322 | Rebecca Morton I322 | 131 | Roosa J709 | Heyman Albert Roosa J709 | 259 |
| Kool J657 | Jacob Barentsen Kool J657 | 222 | Morton J643 | Ephraim Morton J643 | 219 | Roosa J727 | Heyman Albert Roosa J727 | 266 |
| Kool K1313 | Barent Jacobsen Kool K1313 | 332 | Morton K1285 | George Morton K1285 | 319 | Roosa K1277 | Albert Heymans Roosa K1277 | 301 |
| Krom (Crom) L2475 | Willem Krom (Crom) L2475 | 405 | Nagel G72 | Eva Nagel G72 | 68 | Roosa -K1453 | Albert Heymans Roosa - K1453 | 400 |
| Krom K1238 | Maria Willems (Krom) K1238 | 280 | Nagel G86 | Rebecca Nagel G86 | 80 | Roosevelt J640 - J710 | Anna Margriet Roosevelt J640 - J710 | 215 |
| Krom K2475 | Willem Gijsbertsz Krom K2475 | 407 | Nagel H171 | William Nagel H171 | 95 | Roosevelt J710 | Anna Margriet Roosevelt J710 | 259 |
| Kuyper J680 | Tryntje Claesse Kuyper J680 | 240 | Nagel H192 | Eva Nagel H192 | 101 | Roosevelt J728 | Anna Margriet Roosevelt J728 | 266 |
| Kuyper K1359 | Claes Jansen Kuyper K1359 | 361 | Nagel I341 | Barent Nagel I341 | 141 | Rossa -K1417 | Albert Heyman Rossa - K1417 | 392 |
| Lamberts H133 | Cornelis Lamberts H133 | 84 | Nagel J681 | Jan Nagel J681 | 241 | Rutsen I354 | Catherine Rutsen I354 | 147 |
| Lamberts J660 | Geertie Lamberts J660 | 225 | Newkirk J620 | Neeltje Gerritsen Newkirk J620 | 188 | Rutsen I356 | Sarah Rutsen I356 | 148 |
| Laroe J686 | Susanna Laroe J686 | 245 | Nickol I302 | Agatha Nickol I302 | 120 | Rutsen J707 | Jacob Rutsen J707 | 258 |
| LeBlanc J628 | Maria LeBlanc J628 | 200 | Nieffens J720 | Baertje Nieffens J720 | 264 | Rutsen J711 | Jacob Rutsen J711 | 259 |
| Leroy I300 | Marie Anne Leroy I300 | 117 | Pels I290 | Sarah Pels I290 | 110 | Sales J694 | Phoebe, Femmetje Sales J694 | 251 |
| Leroy J599 | Simeon Leroy J599 | 180 | Pels I296 I298 | Sarah Pels I296 I298 | 116 | Sales K1387 | John Sales K1387 | 379 |

The Snyder Family History, all direct line relatives back to the Colonies

| Last name | First/Last Name - GEN | Page | Last name | First/Last Name - GEN | Page | Last name | First/Last Name - GEN | Page |
|-------------------|--------------------------------------|------|------------------------|--|------|------------------------------|--|------|
| Samuels J638 | Arriantje Samuels J638 | 214 | Snyder A2 | Margaret "Marny" Neal Snyder A2 | 31 | Van Couwenhoven | Tryntje Pieterse Van Couwenhoven K1320 | 426 |
| Samuels J726 | Arriantje Samuels J726 | 265 | Snyder C5 | Rev. DeWitt Clinton Snyder C5 | 34 | Van Couwenhoven | Pieter Wolfertsen Van Couwenhoven L2639 | 421 |
| Schepmoes I310 | Maria Schepmoes I310 | 122 | Snyder D9 | Benjamin Franklin Snyder D9 | 39 | Van Couwenhoven | Wolfert Gerritsen Van Couwenhoven M5277 | 422 |
| Schepmoes J619 | Johannes Schepmoes J619 | 188 | Snyder E17 | Jacob Snyder E17 | 45 | Van Dalsen I332 | Geertruyt Van Dalsen I332 | 136 |
| Schepmoes J706 | Jobje Schepmoes J706 | 257 | Snyder E18 | Nellie Snyder E18 | 45 | Van Dalsen J663 | Jan Van Dalsen J663 | 226 |
| Schepmoes K1237 | Dirck Jansen Schepmoes K1237 | 280 | Snyder E24 | Maria Snyder E24 | 48 | Van Dalsen J675 | Capt. Jan Van Dalsen J675 | 236 |
| Schepmoes K1411 | Jan Janszen Schepmoes K1411 | 384 | Snyder F33 | Benjamin Snyder F33 | 53 | Van Dalsen I338 | Elisabeth Van Dalsen I338 | 140 |
| Schepmoes L2473 | Jan Jansz Schepmoes L2473 | 404 | Snyder F35 | Isaac Snyder F35 | 54 | Van Der Burchgraeff | Maycke Hendrieux Van Der Burchgraeff L2716 | 428 |
| Schepmoes L2821 | Jan Pietersz Schepmoes L2821 | 429 | Snyder F47 | Jacob Snyder F47 | 65 | Van Der Schuuren | William Van Der Schuuren K1375 | 375 |
| Schoonmaker I316 | Tryntje Schoonmaker I316 | 128 | Snyder F48 | Nellie Snyder F48 | 65 | Van Duyn J696 | Neeltje Van Duyn J696 | 256 |
| Schoonmaker I316 | Tryntje Schoonmaker I316 | 161 | Snyder G65, G69, H185. | Martinus Henry Snyder G65, G69, H185, H189 * | 66 | Van Esselsteyn | Cornelia Van Esselsteyn H136 | 85 |
| Schoonmaker J631 | Jochem Hendricksen Schoonmaker J631 | 204 | Snyder G93 | Benjamin Snyder G93 | 82 | Van Hardenbergh | Jan Jacobs Van Hardenbergh K1409 | 383 |
| Schoonmaker J731 | Jochem Hendricksen Schoonmaker J731 | 268 | Snyder G95 | Isaac Snyder G95 | 83 | Van Houten I340 | Vroutie Van Houten I340 | 140 |
| Schoonmaker K1261 | Hendrick Jochemse Schoonmaker K1261 | 295 | Snyder H185 * | Martinus Henry Snyder H185 * | 99 | Van Houten J679 | Theunis Roelofse Van Houten J679 | 240 |
| Schoonmaker K1461 | Hendrick Jochemsen Schoonmaker K1461 | 402 | Soales K1388 | Phillip Soales K1388 | 383 | Van Houten K1357 | Roelof Cornelius Van Houten K1357 | 360 |
| Serven G84 | Catharine Serven G84 | 75 | Stephenson 2590 | Margaret Stephenson 2590 | 416 | Van Keuren K1245 | Matthys Jansen Van Keuren K1245 | 288 |
| Serven H167 | Abraham Serven H167 | 93 | Stypers I334 | Katrina Stypers I334 | 137 | Van Naarden L2824 | Aechtje Jans Van Naarden L2824 | 430 |
| Serven I333 | Philip E Serven I333 | 136 | Symens J580 | Jannetje Symens J580 | 174 | Van Naarden Mabilie L2823 | Pieter Casparzen Van Naarden Mabilie L2823 | 430 |
| Seuberige K1374 | Willemetje Roelofs Seuberige K1374 | 374 | Symens J592 J596 | Jannetje Symens J592 J596 | 177 | Van Naerden K1412 | Sara Pieters Van Naerden K1412 | 385 |
| Simons J658 | Marretje Simons J658 | 223 | Symens K1236 | Jannetje Symens K1236 | 279 | Van Naerden L2474 | Sara Pieters Van Naerden L2474 | 405 |
| Slecht J632 | Petronella Slecht J632 | 205 | Thomas K1280 | Jannetje Samuels Thomas K1280 | 312 | Van Ness K1358 | Grietje C Van Ness K1358 | 361 |
| Slecht J732 | Petronella Slecht J732 | 268 | Thomas K1420 | Jannetje Samuels Thomas K1420 | 393 | Van Ness L2715 | Cornelius Hendrick Van Ness L2715 | 426 |
| Slecht K1240 | Chieltje Cornelissen Slecht K1240 | 281 | Thomas K1456 | Jannetje Samuels Thomas K1456 | 401 | Van Nieuw Kirk J635 | Gerret Cornelisse Van Nieuw Kirk J635 | 212 |
| Slecht K1263 | Cornelius Barentsen Slecht K1263 | 296 | Tilley L2592 | Elizabeth Tilley L2592 (1607-1687) | 419 | Van Nieuw Kirk J635 – J715 – | Gerret Cornelisse Van Nieuw Kirk J635 – J715 – | 265 |
| Slecht K1463 | Cornelius Barentsen Slecht K1463 | 403 | Tilley M5179 | John Tilley M5179 | 420 | Van Nieuw Kirk J715 | Gerret Cornelisse Van Nieuw Kirk J715 | 260 |
| Slecht L2479 | Cornelius Barentsen Slecht L2479 | 408 | Tilley M5180 | Joan Hurst R Tilley M5180 | 421 | Van Nieuw Kirk K1239 | Gerret Cornelisse Van Nieuw Kirk K1239 | 281 |
| Slecht L2925 | Barent Cornelissen Slecht L2925 | 438 | Traphagen J622 | Helena Traphagen J622 | 190 | Van Raesveldt J664 | Annatje J Van Raesveldt J664 | 226 |
| Smidt H170 | Margrietje Smidt H170 | 94 | Traphagen K1243 | Willem Jansen Traphagen K1243 | 284 | Van Raetsvelt J676 | Anna Van Raetsvelt J676 | 238 |
| Smidt I339 | Cornelius Smidt I339 | 140 | Trico K1384 | Catalyntje Trico K1384 | 378 | Van Rosenvelt K1279 | Claes Martenszen Van Rosenvelt K1279 | 310 |
| Smidt J669 | Lammert Ariaensen Smidt J669 | 226 | Trico L2832 | Catalyntje Trico L2832 | 433 | Van Rosenvelt K1419 | Claes Martenszen Van Rosenvelt K1419 | 393 |
| Smidt J677 | Lammert Ariaensen Smidt J677 | 239 | Tuenessen I347 | Denyse Tuenessen I347 | 144 | Van Rosenvelt K1455 | Claes Martenszen Van Rosenvelt K1455 | 401 |
| Smidt K1337 | Adriaen Lambertsen Smidt K1337 | 342 | Tybout K1370 | Madame Tybout K1370 | 368 | Van Slyck I360 | Tryntje Van Slyck I360 | 160 |
| Smidt K1353 | Adriaen Lambertsen Smidt K1353 | 359 | Van Bommel H152 | Margaret Van Bommel H152 | 87 | Van Slyck J719 | Willem Pieterse Van Slyck J719 | 263 |
| Smith H168 | Breghejje Smith H168 | 93 | Van Bommel I303 | Peter Van Bommel I303 | 121 | Van Slyck K1437 | Pieter Tennis Van Slyck K1437 | 395 |
| Smith I335 | Gerrit Smith I335 | 137 | Van Bommel J605 | Hendrick Van Bommel J605 | 183 | Van Slyck K1439 | Cornelis Antonissen Van Slyck K1439 | 396 |
| Snyder – B3 | Laurence Hasbrouck Snyder – B3 | 32 | Van Breestede K1462 | Elyse Jan Van Breestede K1462 | 402 | Van Voorhees I344 | Margritie Albertse Van Voorhees I344 | 143 |
| Snyder H189 * | Martinus Henry Snyder H189 * | 101 | Van Couwenhoven | Tryntje Pieterse Van Couwenhoven K1320 | 338 | Van Voorst K1323 | Ide Van Voorst K1323 | 340 |

The Snyder Family History, all direct line relatives back to the Colonies

| Last name | First/Last Name - GEN | Page | Last name | First/Last Name - GEN | Page | Notable Sections of the Book | Page |
|-----------------------------------|--|------|------------------------|------------------------------------|------|---|------|
| Van Wagenaar K1153 | Jacob Aertse Van Wagenaar K1153 | 270 | VanDerSchuerle J688 | Helena/ Elena VanDerSchuere J688 | 246 | | |
| Van Wagenaar K1177 | Jacob Aertse Van Wagenaar K1177 | 274 | Vanschoenderwoer K1413 | Rutger Jacobson Vanschoenderwoer | 385 | Letter from Solomon Du Bois 1863 | 153 |
| Van Wagenaar K1185 | Jacob Aertse Van Wagenaar K1185 | 277 | Vanschoenderwoer K1421 | Rutger Jacobson Vanschoenderwoer | 393 | Blauvelt – Second Generation and Tappan Patent | 234 |
| Van Wageningen D10 | Margaret Van Wageningen D10 | 41 | VanVoorhees J687 | Albert Stevense VanVoorhees J687 | 246 | Coat of Arms: | 23 |
| Van Wageningen E19 | William D Van Wageningen E19 | 46 | VanVoorhees K1373 | Steven Coerte VanVoorhees K1373 | 369 | Dutch Names and Their English Equivalent | 25 |
| Van Wageningen F37 | Jacob Van Wageningen F37 | 55 | Vanvoorst K1360 | Annatje Cornelisse Vanvoorst K1360 | 362 | Dutch Names and why are they hard to trace: | 29 |
| Van Wageningen F38 | Margaret Du Bois Van Wageningen F38 | 55 | VanVorst J662 | Annetje VanVorst J662 | 225 | Dutch Patronymics / naming convention of the 1600s: | 26 |
| Van Wageningen G73 | Jacob Aertse Van Wageningen G73 | 68 | VanYsselstein K1259 | Jan Willemszen VanYsselstein K1259 | 294 | Glossary of Dutch Terms | 24 |
| Van Wageningen G75 | Isaac Van Wageningen G75 | 69 | VanYsselstein K1459 | Jan Willemszen VanYsselstein K1459 | 401 | How to read this compilation of Genealogy: | 21 |
| Van Wageningen H145 | Aert Aertse Van Wageningen H145 | 85 | Verbeau J602 | Jeanne Verbeau J602 | 182 | Introduction: Snyder Genealogy | 20 |
| Van Wageningen H148 | Rebecca Van Wageningen H148 | 86 | Verbeau K1252 | Jeanne Verbeau K1252 | 294 | Mayflower Genealogy: | 133 |
| Van Wageningen H149 | Isaac Van Wageningen H149 | 86 | Von Brees K1414 | Tryntji Janse Von Brees K1414 | 387 | Terminology Used By Our Ancestors | 22 |
| Van Wageningen H155 | Johannes Van Wageningen H155 | 88 | Von Brees K1422 | Tryntji Janse Von Brees K1422 | 393 | Section I – Introduction to the compilation of Snyder Lineage | 19 |
| Van Wageningen I289 | Jacob Aertsen Van Wageningen I289 | 105 | von Breestede L2827 | Jan Janse von Breestede L2827 | 431 | Section II – Family Detail by Generation | 30 |
| Van Wageningen I289 - I295 - I297 | Jacob A. Van Wageningen I289 - I295 - I297 | 20 | Wageningen G78 | Maria Van Wageningen G78 | 69 | Pedigree for Gen A – D | 38 |
| Van Wageningen I295 I297 | Jacob Aertsen (Van Wageningen) I295 I297 | 116 | Waldron (2) K1363 | Resolved Waldron (2) K1363 | 362 | Section III a. –Snyder Lineage Pedigrees Gen A - H | 443 |
| Van Wageningen I309 | Simon Van Wageningen I309 | 121 | Waldron J674 | Marretje Waldron J674 | 231 | Section III b. –Snyder Lineage Gen H- M Pedigrees | 450 |
| Van Wageningen J577 | Aert Jacobsen Van Wageningen J577 | 170 | Waldron J682 | Rebecca Waldron J682 | 242 | Section IV – INDEX Snyder/Petersen Lineage | 496 |
| Van Wageningen J589 J593 | Aert Jacobsen Van Wageningen J589 J593 | 177 | Waldron K1347 | Joseph Waldron K1347 | 357 | Source: | 441 |
| Van Wageningen J617 | Gerrit Aertsen Van Wageningen J617 | 185 | Wibau I294 | Jannetje Wibau I294 | 115 | TABLE OF CONTENTS | 3 |
| Van Wageningen K1233 | Aert Jacobsen Van Wageningen K1233 | 279 | Wolters K1365 | Kier Wolters K1365 | 364 |  | |
| VanBreestede K1262 | Elsie J VanBreestede K1262 | 296 | Wood C6 | Gertrude Louisa Wood C6 | 34 | | |
| VanBreestede L2523 | Jan Janszen VanBreestede L2523 | 409 | Wood D11 | Ebenezer B Wood D11 | 42 | | |
| Vandenbergh K1436 | Catharina Vandenbergh K1436 | 395 | Wood E21 | Benjamin Wood E21 | 47 | | |
| Vanderbeeck J691 | Rem Jansen Vanderbeeck J691 | 249 | Wood F41 | Benjamin Wood F41 | 56 | | |
| Vanderbilt F44 | Jannetje Vanderbilt F44 | 64 | Wood G81 | Ebenezer Wood G81 | 71 | | |
| Vanderbilt G87 | Dirck Vanderbilt G87 | 80 | Wood H161 | Jabez Wood H161 | 91 | | |
| Vanderbilt H173 | Jacob Vanderbilt H173 | 95 | Wood I321 | Samuel Wood I321 | 131 | | |
| Vanderbilt I345 | Aris Janse Vanderbilt I345 | 143 | Wood J641 | Henry Wood J641 | 216 | | |
| Vanderbilt J689 | Jan Aertsen Vanderbilt J689 | 247 | Wood K1281 | John Wood K1281 | 312 | | |
| | | | Wood L2561 | Nicholas Wood L2561 | 411 | | |